



Australian Government

Department of Defence

Defence Support Group

RAAF BASE TINDAL
REDEVELOPMENT STAGE 5
Katherine, Northern Territory

STATEMENT OF EVIDENCE
TO THE
PARLIAMENTARY STANDING COMMITTEE
ON PUBLIC WORKS

Department of Defence
Canberra, ACT
February 2008

INTENTIONALLY BLANK

Table of Contents

PART A - IDENTIFICATION OF THE NEED	1
PROJECT OBJECTIVES	1
HISTORICAL BACKGROUND	1
THE NEED FOR THE WORK	3
DESCRIPTION OF THE PROPOSAL	3
OPTIONS CONSIDERED AND REASONS FOR ADOPTING PROPOSED COURSE OF ACTION	6
ENVIRONMENTAL IMPACT ASSESSMENT	6
HERITAGE CONSIDERATIONS	6
CONSULTATION.....	7
REVENUE.....	7
PART B - TECHNICAL INFORMATION.....	8
LOCATION	8
PROJECT SCOPE	8
SITE.....	10
ZONING AND APPROVALS	11
LAND ACQUISITION.....	11
APPLICABLE CODES AND STANDARDS	11
PLANNING AND DESIGN CONCEPTS	11
ACOUSTICS	13
ECOLOGICALLY SUSTAINABLE DEVELOPMENT.....	14
WATER AND ENERGY CONSERVATION	15
MASTER PLANNING AND FUTURE DEVELOPMENT	16
DISABLED ACCESS.....	17
HERITAGE ISSUES	17
CHILD CARE PROVISIONS	17
FIRE PROTECTION AND SECURITY.....	18
OCCUPATIONAL HEALTH AND SAFETY.....	19
LANDSCAPING	19
INDUSTRY AND COMMUNITY IMPACTS	19
PROJECT COSTS	20
PROJECT DELIVERY SYSTEM.....	20
CONSTRUCTION TIMEFRAME	20
ANNEXES.....	21

PART A - IDENTIFICATION OF THE NEED

PROJECT OBJECTIVES

1. This statement of evidence to the Parliamentary Standing Committee on Public Works presents a proposal for the redevelopment of facilities at RAAF Base Tindal for examination and recommendation to Parliament.
2. The RAAF Base Tindal Redevelopment Stage 5 Project consists of twelve discrete project elements, developed with the objective of improving the facilities which support the overall capability of RAAF Base Tindal. Most of the facilities at the base were constructed in the 1980s and were generally not designed to support current activity rates. Some twenty years after their construction, many of the base facilities are, in any case, in need of refurbishment.
3. The major units which use the facilities concerned are:
 - a. No 75 Squadron, which operates the F/A-18 fighter aircraft; and
 - b. No 322 Expeditionary Combat Support Squadron, which provides the support functions for units using the base.
4. The project objectives are to improve the operational and support capabilities assigned to the base, rectify limitations and deficiencies in base facilities and enhance the working environment to an acceptable level for base personnel.

HISTORICAL BACKGROUND

5. A decision was made in 1956 that a site was to be selected for an airfield which would be 'mutually supporting with Darwin'. The present site satisfied the conditions that the site not be 'subjected to fall out from a nuclear weapon aimed at Darwin, be easily accessible by road or railway, have an adequate water supply and to be no further from Darwin than 200 miles (322 kilometres)'. RAAF Base Tindal, a former World War II airfield, was subsequently reconstructed as a bare base, with facilities for deployed squadrons, by the RAAF's No 5 Airfield Construction Squadron during the 1960s. In 1984 the Government made a decision to establish the base as a manned, operational military airfield. The first stage of its development, providing for the permanent basing of a tactical fighter squadron,

was the subject of the Parliamentary Standing Committee on Public Works Twelfth Report of 1984.

6. The base is a link in a chain of Australian Defence Force airfields stretching across northern Australia from Learmonth in Western Australia to Townsville in northern Queensland. It is the home base for No 75 Squadron, a tactical fighter squadron equipped with F/A-18 Hornets. RAAF Base Tindal is also a staging base for exercises conducted in the area and in conjunction with Delamere Air Weapons Range, located some 150 kilometres to the south-west, it is used extensively to exercise deployed RAAF elements. The range, through bilateral Defence agreements, also accommodates a number of overseas air force exercises.

7. Subsequent development of the Base is covered by the following Public Works Committee Reports:

- a. Tenth Report of 1988 - "Stage 2 Development of RAAF Base Tindal" at a cost of \$34.9m (plus \$2.75m for married quarters), where the main investment was in taxiway extensions, technical and support facilities and associated engineering services;
- b. Ninth Report of 1991 - "Stage 3 Development of RAAF Base Tindal" at a cost of \$53.5m, where the main investment was in aircraft shelters with associated pavements, facilities and engineering services;
- c. Third Report of 1996 - "Development of Operational Facilities at RAAF Base Tindal" at a cost of \$31.4m, where the main investment effort was in operational facilities for maritime patrol aircraft, extension of the air movements apron, Base Command Post, contingency accommodation and engineering services;
- d. Seventh Report of 2003 - "Perimeter Security Fence RAAF Base Tindal".

8. Annex A illustrates the location of RAAF Base Tindal, and Annex B provides a current plan of the base layout.

THE NEED FOR THE WORK

9. The project comprises twelve separate elements, each involving either the refurbishment, upgrading or replacement of existing facilities. The need for these works is related either to increased demand for the function supported by the facility, or to deficiencies in relation to current security, Occupational Health and Safety (OH&S) or industry standards. The deficiencies of the existing facilities are outlined in the following descriptions of the works proposed.

DESCRIPTION OF THE PROPOSAL

10. The location of each of the project elements is identified on the plan at Annex C and sketch plans of each element are included at Annex D. The works proposed are:

- a. **Element 1. Security Fence Extension.** The explosive storage and preparation facilities on the base are currently enclosed by chain mesh fences of poor quality. Further, the facilities are not incorporated into the secure area defined by the Base perimeter security fence. Extensions of the perimeter security fence are required at two locations to correct this deficiency.
- b. **Element 2. Central Emergency Power Station.** The Defence standard established for the provision of emergency power on the base is that the Central Emergency Power Station must be capable of meeting 70% of the peak daily load. Based on current demand this standard is met, but with planned new facilities an increase in emergency power capacity will be required.
- c. **Element 3. Ordnance Loading Apron Water Supply.** There is no permanent water reticulation to the twelve ordnance loading aprons used by No 75 Squadron. Water is currently supplied by tanker and stored in small tanks, with pumps providing the necessary pressures. This water can only be used for emergency eye wash and deluge shower installations. This arrangement creates a number of OH&S risks due to the vulnerability of the systems to heat, contamination and to power and mechanical failure. A mains water supply will eliminate these problems and mitigate the risks. It will also enable the installation of drinking water, hydrants, hose reels and septic tank toilets and relieve the significant drain on manpower which the current resupply arrangements involve.

- d. **Element 4. Liquid Dry Breathing Oxygen Facility.** Liquid dry breathing oxygen is used by 75 Squadron and other aircraft units operating from the base. A facility is needed to receive and store the oxygen, and for the weather protection of the equipment used for delivery to user units. The facility in present use does not comply with current standards and does not meet the required safety distance separation from a nearby fuel farm. A new facility is required.
- e. **Element 5. Aircraft Maintenance Annexes.** Maintenance of 75 Squadron's F/A-18 aircraft is conducted from the North and South Annexes of two adjacent hangars. Maintenance workloads have increased substantially since the squadron was established at RAAF Base Tindal in 1988, necessitating a doubling of maintenance personnel, who operate from the annexes on a two shift basis. The inadequate facilities cause inefficiencies and OH&S difficulties and could have adverse impacts on aircraft maintenance standards. Expansion of both annexes is required to correct the deficiencies.
- f. **Element 6. Inflight and Surge Catering.** Catering for personnel permanently based at RAAF Base Tindal is done at the Officers', Sergeants' and Airmen's messes. Crew and passengers of aircraft operating from or transiting through the base and personnel deployed to the base for operational reasons or for exercises were catered from a demountable kitchen which provided inflight, and hotbox meals. The demountable building has been condemned for structural and OH&S reasons. As an interim measure, the inflight and surge catering function is being performed at the Airmen's mess in unsuitable facilities not designed for that purpose.
- g. **Element 7. Ordnance Loading Apron Security.** Ten visiting aircraft parking aprons have been provided for the loading of explosive ordnance on to aircraft operating from the base during exercises or in contingency circumstances. New missile systems have classified components that require appropriate security protection. The aprons have no electronic security monitoring capability, which necessitates picqueting of the aprons by security guards when they are in use. A security system is required at the aprons to monitor aircraft when loaded with these missile systems.

- h. **Element 8. Tanker Maintenance and Refuelling Facilities.** The refuelling of aircraft on the base is predominantly by road tanker. The maintenance of fuel tankers is a function which is interrelated with operation of the fuel farm and the delivery of fuel by tanker to aircraft. However, the two functions are currently conducted from dispersed locations and operate from inadequate facilities, some of which are demountables. There is a need to provide new maintenance facilities which meet current OH&S and industry standards and to improve efficiency by collocating refuelling and maintenance operations.
- i. **Element 9. Fire Station.** As a consequence of the increase in aircraft operations from the base, the classification of the fire station has been lifted from Airfield Rescue Fire Fighting Category 4, when it was constructed, to Category 6. Associated with this has been a doubling of personnel numbers and an increase in the number and size of fire fighting vehicles. This necessitates extensions and improvements to the existing fire station and training facilities.
- j. **Element 10. Supply Services Warehouse.** The levels of logistic support required at RAAF Base Tindal have increased significantly since the base was established and the existing primary warehouse was built. Because of insufficient space in this warehouse, some stores are now held in a 1960s prefabricated Bellman Hangar. This hangar is in a remote location and does not comply with Defence standards for use as a storage facility. Additional permanent pallet racking and receipt and dispatch areas are needed in the existing primary warehouse, as is the refurbishment of current office space, the replacement of the existing carousel and improvements to fire protection. The provision of these improvements will permit the collocation of stores and the demolition of a Bellman Hangar.
- k. **Element 11. Messing Improvements.** Constant, high level use of the kitchens in the three messes over the past twenty years has led to deterioration of the work areas, equipment and finishes. This deterioration has resulted in a number of OH&S deficiencies, inefficiencies and increasing operating and maintenance costs. General refurbishment, including the remodelling of

kitchen benches, the replacement of equipment and improvements to emergency lighting and fire protection systems is required.

1. **Element 12. Passenger Terminal.** The facilities initially provided for the handling of passengers and their baggage are now inadequate because of increased numbers using the facility. Expansion of both indoor and outdoor spaces is required to relieve the congestion, facilitate some segregation between passenger groupings when required and improve the processing of arriving and departing passengers.

OPTIONS CONSIDERED AND REASONS FOR ADOPTING PROPOSED COURSE OF ACTION

11. The redevelopment project is driven by the inability of existing facilities to support the increased activity rates of the two principal units and to support the introduction of new equipments and weapons systems. In most cases, the proposed works will extend, upgrade or replace existing facilities. There are no other facilities available to meet the requirements identified for this project. While optional design solutions have been examined within each element in the processes of design development and value management, there are no practical alternatives to proceeding with the upgrading or replacements proposed.

ENVIRONMENTAL IMPACT ASSESSMENT

12. An Environmental Assessment Report has been completed and a determination has been made that there are no aspects of the project that constitute a controlled action, so referral under the *Environment Protection and Biodiversity Conservation Act 1999* is not required. The Report did however recommend a number of measures to be implemented to mitigate any adverse environmental impacts which may arise during the construction phase or during subsequent operation of the facilities. Construction will be undertaken with reference to a Construction Environment Management Plan which will take into account the recommended mitigation measures. Construction will not commence until an Environmental Clearance Certificate has been issued.

HERITAGE CONSIDERATIONS

13. Aboriginal archaeological and anthropological sites exist on RAAF Base Tindal. The Environmental Assessment Report identified three sites of significance which are near

facilities proposed in the project. The Aboriginal Areas Protection Authority has been approached to undertake site investigations which will include further examination of those sites and the implications for the proposed facilities. The investigation report will identify the requirements that are to apply during final design and construction.

CONSULTATION

14. The following external authorities have been or will be consulted about the project:

- The Federal Member for Lingiari;
- The Department of Environment, Water, Heritage and the Arts;
- Department of Climate Change;
- NT Department of Planning and Lands;
- NT Department of Business and Economic Development;
- NT Department of Regional Development;
- NT Department of Defence Support;
- NT Department of Natural Resources, Environment and Heritage;
- The Katherine Town Council;
- Northern Territory Power and Water Authority;
- The Aboriginal Areas Protection Authority;
- Northern Land Council
- The Northern Territory Fire and Rescue Service;
- The Chamber of Commerce Northern Territory; and
- The Territory Construction Association.

15. The Department held industry and community briefings in Darwin and Katherine in March 2007 to acquaint interested parties of this and other Defence projects in the Northern Territory.

REVENUE

16. There are no revenue implications.

PART B - TECHNICAL INFORMATION

LOCATION

17. RAAF Base Tindal is located approximately 330 kilometres by road south of Darwin and 15 kilometres south of Katherine. A location plan is at Annex A.

PROJECT SCOPE

18. The work proposed for each of the Elements is summarised below. Sketch plans of each element are at Annex D.

- a. **Element 1. Security Fence Extension.** It is proposed to extend the existing base perimeter security fence to enclose the explosive ordnance storage and preparation areas in the south-east of the base and the explosive ordnance preparation area in the north. Approximately 7.2km of fencing is to be constructed. The fence will be of the same design as that existing and will incorporate the same surveillance camera and monitoring features.
- b. **Element 2. Central Emergency Power Station.** The supply and installation of an additional 1MW diesel generator in the emergency power station is proposed. The station holds three generators and was designed to accept a fourth generator, should such a need arise. The project will acquire and install the generator and provide a transformer, a control panel and switch gear.
- c. **Element 3. Ordnance Loading Apron Water Supply.** The reticulation of mains water to the 75 Squadron aprons will replace the current reliance on tank water. It will ensure a reliable supply for personal use and for safety appliances including deluge showers and emergency eye washes. It will also enable the installation of septic tank toilets, fire hydrants and hose reels.
- d. **Element 4. Liquid Dry Breathing Oxygen Facility.** The proposed work will provide a covered, weather protected area for two 7000L storage tanks, a drive through capability for off-loading liquid oxygen from road trains and a covered parking area for the trolleys and tow motors which handle the transfer of oxygen to the flightlines. The scope of work will include an evaporation pit, security fencing, security lighting and lightning protection. A light vehicle access road will be constructed from the facility to the 75 Squadron precinct.

- e. **Element 5. Aircraft Maintenance Annexes.** The proposal is to extend each annex, to rearrange some internal spaces and to construct new toilet, shower and locker facilities adjacent to each annex.

- f. **Element 6. Inflight and Surge Catering.** The new facility proposed will meet three functions; the preparation of meals for crew and passengers of outgoing flights, preparation of 'hot box' meals for personnel working at operational sites during exercises and operations and a sit down dining capacity for operational staff 'inside the wire', particularly during surge periods. The design is based on a central, common stores area, but with separated kitchen areas for domestic and inflight preparation and distribution operations. A sit down dining room with a capacity for 100 personnel is a component of this work.

- g. **Element 7. Ordnance Loading Apron Security.** The proposed security system at the visiting fighter aprons will comprise one fixed and two pan tilt zoom CCTV cameras with motion detection capability fitted to the roof of each of the ten ordnance loading aprons. The system will be connected to security monitoring panels at the flightline of the visiting fighter operations facility and at the base guardhouse.

- h. **Element 8. Tanker Maintenance and Refuelling Facilities.** A new tanker maintenance and tanker drivers' facility is proposed. The design of the new facilities is influenced by the need to separate tanker maintenance from ignition sources, to have fire separation between work bays and to separate office areas from maintenance areas. The maintenance building will provide four fire separated maintenance bays, a small parts repair workshop, a store and a vehicle wash bay. A separate building will provide offices, training, amenities and change facilities and will also provide facilities for drivers working from the nearby fuel storage facility.

- i. **Element 9. Fire Station.** The proposed upgrade includes two additional fire fighting vehicle bays, a stores area and a new change/toilets/laundry area. A two metre wide awning is proposed on both sides of the existing vehicle bays to accommodate the new, larger fire trucks currently being procured. Internal

fittings and finishes will be refurbished and a two storey structural training facility will be constructed a short distance from the fire station.

- j. **Element 10. Supply Services Warehouse.** The proposal is to extend the existing warehouse to provide a substantial increase in pallet racking space and to provide additional receipt and dispatch floor area. It is also proposed to refurbish office space, replace the carousel and refurbish and augment the warehouse fire protection system.
- k. **Element 11. Messing Improvements.** The work proposed in the Airmen's, Sergeants' and Officers' messes is designed to improve the functionality of kitchen layouts, to replace worn and obsolete equipment and to undertake a general refurbishment of all finishes. The scope of work includes the remodelling of kitchen benches, the installation of a range of new kitchen equipment, new floor finishes, repainting, the upgrade of emergency lighting and fire suppression systems and improvements to floor drainage.
- l. **Element 12. Passenger Terminal.** It is proposed to expand both indoor and outdoor spaces in the current terminal. Indoor extensions will be confined to the existing building envelope and new outdoor shaded extensions are proposed to help handle the higher numbers of passengers. The existing baggage collection space will be enclosed to become part of the new waiting area and baggage collection will be relocated to an outside, partially covered area.

SITE

19. RAAF Base Tindal has a single runway, 2742 metres in length and 45 metres wide, in a generally NW-SE orientation. Operational and support facilities are sited to the east and the north of the runway and taxiway system in zones according to their function. The facilities affected by this submission are located throughout these zones. The siting of each work element has been reviewed and re-confirmed as part of the design development process. Annex B illustrates the base layout.

ZONING AND APPROVALS

20. The property is owned by the Commonwealth and controlled by the Department of Defence. It is zoned for Defence Purposes under the Katherine Land Use Structure Plan. As all works under this proposal will be sited on Commonwealth owned land, local authority approvals for the development are not required, although Defence will comply with national, territory and municipal requirements.

LAND ACQUISITION

21. No land acquisition is involved in this project.

APPLICABLE CODES AND STANDARDS

22. The building components have, to varying degrees, elements of civil, structural, mechanical, electrical, hydraulic, fire protection and communications services. These will all comply with the relevant Australian, Northern Territory and Defence codes and standards, including:

- a. Building Code of Australia (BCA);
- b. Australian Standards;
- c. Defence Manual of Fire Protection Engineering;
- d. Occupational Health and Safety Act 1991;
- e. Defence Security Manual; and
- f. Northern Territory Building Act and Regulations 1993.

PLANNING AND DESIGN CONCEPTS

23. **Architectural and Structural.** Because the project primarily comprises upgrades and extensions to existing buildings, it is appropriate that the works follow the precedents already set for development of the base, subject to this approach representing value for money solutions.

24. Generally, existing buildings are of concrete slab on ground, with steel framing and colorbond profiled steel sheet clad walls and roofs. In some cases a barrel vaulted form combines wall and roof in a single clad element. Existing roofs generally incorporate curved ridges and bullnose eaves. There are some examples of blockwork and brickwork wall

construction and these will be considered for new work where more solid wall construction is advantageous for durability, security, acoustics or other reasons. For external materials, pre-finished and self-finished materials will be given preference to minimise ongoing maintenance.

25. Where significant new ablutions are required, these will generally be located as separate blocks, within easy access for users. With ESD considerations in mind, initiatives such as maximising cross ventilation will be applied.

26. **Civil Engineering.** Short access roads are required for new buildings and facility extensions. Designs will be based on 40kph speed limits, a pavement life of 25 years and in accordance with relevant Austroads Standards. Roads will generally be asphalt surfaced although some apron areas involving heavier vehicles will be in concrete.

27. Stormwater drainage will take into account stormwater runoff and the location of flame traps and pollution controls. Drainage will maximise the use of open swales and surface grading while minimising the use of underground pipes. Design will be based on relevant standards including AS3500.3 Stormwater Drainage.

28. **Electrical.** The base has an 11kV incoming supply from the NT Power and Water Authority supply network to the base Intake Station. Three ring mains supply substations in various areas of the base before terminating at the central emergency power station. There is an interconnector from the Intake Station to the central emergency power station allowing each ring main to be supplied from either end, thus providing redundancy of supply. Substations on the ring mains supply low voltage power to each base facility, generally by underground supply.

29. **Mechanical.** Air conditioning and ventilation systems are key elements in the design of facilities in the Tindal environment. They will be designed to achieve adequate indoor environmental comfort and health conditions in an energy efficient manner. The objectives established for the Stage 5 facilities are that these systems should be:

- a. Reliable and easy to maintain and repair;
- b. Of optimum capacity and adjustable to suit various load conditions;
- c. Energy efficient and incorporating sustainable design features; and

d. Optimised for minimum life cycle cost.

30. The systems will generally be designed in accordance with the BCA, relevant Australian standards and the NT Building Act and Regulations 1993.

31. Extended and new office and working areas will generally be supplied with ducted split systems, although some areas being renovated will require the reconfiguration of existing systems and new condenser units. Enclosed bays in the Tanker Maintenance facility will have exhaust systems for fume extraction including retractable hoses for connection to vehicle exhausts. Toilet and shower rooms, plant rooms and switch rooms will generally be mechanically ventilated.

32. **Hydraulics.** The base is serviced with a combined fire and domestic water reticulation system. This will be utilised to supply all potable water to the sites concerned.

33. Solar hot water systems will be examined for all hot water locations. They are expected to be employed for the larger and regular hot water demands. Elsewhere, electric mains pressure hot water units, sized to meet localised demands, will be installed.

34. New sewerage connections will be pumped rising mains to adjacent gravity sewers. The Tanker Maintenance facility will incorporate waste fuel and oil collection and reticulation systems. The wash bay waste will be treated before discharge to the sewerage system. Septic tanks will be installed at the 75 Squadron Ordnance Loading Aprons.

ACOUSTICS

35. Most of the facilities in the project are located outside the 20 Australian Noise Exposure Forecast (ANEF) contour and will not require particular noise reduction measures. Areas such as offices and training rooms will include acoustic ceiling tiles and acoustic insulation.

36. The Fire Station is located between the 25 and 30 ANEF contours and the new sleeping room and office area proposed will require a higher level of noise attenuation. For operational reasons, the passenger terminal lies between the 30 and 35 ANEF contours. Concrete block external walls, 10mm laminated glazing and a lower acoustic ceiling are proposed for noise attenuation in this facility.

ECOLOGICALLY SUSTAINABLE DEVELOPMENT

37. The Commonwealth is committed to Ecologically Sustainable Development and the reduction of greenhouse gas emissions. The project has addressed this by adopting cost effective Ecologically Sustainable Development measures as part of the design and delivery of the new buildings and refurbishments included in the project.

38. Several elements of the project, such as the Security Fence Extension and Central Emergency Power Station augmentation, involve improvements to infrastructure which are not relevant to the application of these initiatives. Most of the other elements of the project involve extension or refurbishment of existing buildings, which places some limitations on the extent to which Ecologically Sustainable Development initiatives can be efficiently applied. However for new buildings, and where feasible for extensions of existing structures, the Ecologically Sustainable Development design initiatives which have been taken include:

- a. Building form and fabric. Energy use will be reduced by passive design features. Where feasible, building designs will be narrow, aligned east-west but offset slightly to maximise ventilation from NW and SE seasonal winds. North and south glazing will be shielded from solar radiation. Glazing on east and west facades will be minimised, with landscaping used for shading. Vapour barriers will be incorporated in external envelopes of air conditioned buildings.
- b. Energy use minimisation. Energy use will be reduced by cost-effective design features. The use of night purge strategies and high efficiency internal blinds will supplement building orientation, thermal performance and façade treatment. Demand management will include the use of high efficiency lighting, occupant and daylight controlled lighting, and the use of simple, intuitive controls. Air conditioned areas will be zoned with localised switching, including after hours time switching. Systems will incorporate high efficiency motors, fans, pumps and filtration, and all pipework and ducts will be insulated. High efficiency light fittings will be used, with light switch labelling, occupancy sensors in intermittently used rooms, separate switching to individual spaces and time clock controls of appliances such as boiling water units.

- c. Water use reduction. Potable water use will be reduced by cost-effective design features. Demand management measures will include the general use of water efficient fixtures; sanitary fixtures will comply with best practice ratings. Dual flush cisterns, sub-metering of water usage, flow control valves on taps, and minimising dead legs on hot water systems will be employed. Landscaping has been designed to address location and climate with planting selection including native plant and grass species in the landscaping design with reduced irrigation requirements.
- d. Waste minimisation. Design strategies will be focussed on minimising the quantum of material going to landfill both during construction and through the life of the facilities. Approaches will include: designing to standard construction material dimensions, minimising off-cuts; giving emphasis to designs which are flexible and which facilitate re-use of materials when space allocation changes are necessary; development of a waste management, materials input and waste tracking plan during construction; designing for waste streaming when the facilities are in use.
- e. Choice of materials. Materials will be selected from those readily available locally for their functionality, durability, low maintenance and for their ESD properties to minimise impacts on environment. Durable materials will be selected that can be dismantled and reused/recycled to promote flexibility of internal spaces; use of plantation timbers is to be maximised; avoidance of toxicity particularly in fit out materials selection.

WATER AND ENERGY CONSERVATION

39. Defence reports annually to Parliament on its energy management performance in accordance with the Energy Efficiency in Government Operations policy and on its progress in meeting the energy efficiency targets established by the government. Defence is committed to the implementation of policies and strategies in energy, water and waste management to improve natural resource efficiency and to support its commitment to the reduction of energy consumption, potable water consumption and waste diversion to landfill.

40. All buildings included in this project will be designed, constructed, operated and maintained to ensure that they use energy efficiently. To achieve this, as a minimum, the buildings will comply with:

- a. Part I2 of Volume One of the BCA;
- b. Part 3.12 of Volume Two of the BCA;
- c. the Energy Efficiency in Government Operations policy; and
- d. Defence Green Building Requirements;

41. All buildings will comply with the relevant energy efficiency provisions in the BCA, except where there are energy efficiency requirements imposed by Defence Green Building Requirements - Part 1 that are of a higher standard. In this instance, there are no Defence energy efficiency requirements of a higher standard than the BCA.

42. Defence has adopted the principles of the Energy Efficiency in Government Operations (EEGO) policy in relation to office accommodation less than 2000 m², with separate digital metering and lighting less than 10 watts per square metre. This includes the Aircraft Maintenance Annexes, the Tanker Maintenance Facility, the Fire Station and the Supply Services Warehouse. Separate metering to other facilities will be applied in accordance with the Defence metering strategy. An Energy Management Plan will be developed for implementation by Defence. Where available, fit for purpose and cost-effective appliances will be US EPA 'Energy Star' compliant with power management features enabled at the time of supply.

43. The Department of Climate Change and the Department of Environment, Water, Heritage and the Arts have been consulted with respect to these energy efficiency measures.

44. The design strategies outlined in the previous section will promote Defence's capacity to achieve its water and energy conservation objectives on the base.

MASTER PLANNING AND FUTURE DEVELOPMENT

45. Most of the project elements involve extending or upgrading existing facilities whose locations are consistent with the 1996 Master Plan. The siting of the proposed new works has been confirmed in accordance with formal Defence facilities siting procedures.

46. In relation to future developments, the Department of Defence is acquiring six Airborne Early Warning and Control (AEW&C) aircraft, a Boeing 737 variant, which will deploy to RAAF Base Tindal for extended periods each year. The first aircraft are scheduled for delivery in mid 2009 and a number of new facilities must be constructed at RAAF Base Tindal to support their operations. With the Committee's agreement, an operations facility was brought forward and is now under construction. The balance of the project is the subject of a separate submission to the PWC. The works proposed include:

- a. Taxiways and three aircraft parking aprons, two of which have aircraft shelters;
- b. Technical and logistics support facilities; and
- c. Hydrant refuelling at each of the aircraft parking aprons.

47. An additional weapon storage facility will be constructed in the Explosive Ordnance storage precinct. This project is required to be completed by July 2009.

DISABLED ACCESS

48. New building work will comply with the access requirements of Australian Standard 1428.1 as considered appropriate in the operational context.

HERITAGE ISSUES

49. There are Aboriginal archaeological and anthropological sites on the Base and sites of significance have been previously identified.

50. Following site investigations by the Aboriginal Areas Protection Authority, a Certificate will be issued which will form the basis for management of final design and construction of project elements in relation to those sites.

CHILD CARE PROVISIONS

51. A child care facility for Australian Defence Force personnel and civilian staff is located within the community precinct of the Base. The facility is appropriate for its purpose and none of the work proposed will increase the childcare liability. No childcare related works are proposed under this project.

FIRE PROTECTION AND SECURITY

52. All construction and fire protection requirements will, as a minimum, be in accordance with the provisions of the BCA, the Defence Manual of Fire Protection Engineering and all other applicable Codes and Standards. The Manual of Fire Protection Engineering details Defence fire protection policy for asset protection and building function protection. The levels of fire protection specified are above BCA requirements and have been determined by a risk assessment and risk management approach to fire protection.

53. Defence will require certification from a suitably qualified and accredited building surveyor, that the design and construction meet the requirements of the BCA, the Manual of Fire Protection Engineering, relevant Codes and Standards and any additional State, Local Government and Defence requirements.

54. While not the first response, the Northern Territory's Fire and Rescue Service will be invited to comment on the project, visit the site and offer comment throughout the construction phase to ensure that the Brigade's operational requirements are met.

55. Any recommended departures from BCA requirements in relation to the project will be technically assessed by Defence specialist fire protection staff and where warranted by the scope of the departure, a suitably qualified and experienced fire engineer. Agreed departures, ensuring an equivalent or higher level of protection than BCA requirements, will require written approval from the appropriate Defence delegate.

56. Successful tenderers will be required to produce a Quality Assurance Plan to clearly show how BCA, Australian Standards and any additional Defence requirements in relation to fire protection/fire safety will be met and the required standards for construction and installation maintained.

57. All Fire Indicator Panels will be connected to the master Fire Indicator Panel at the fire station which is manned on a 24 hour basis.

58. The Emergency Warning and Intercommunication System main panel will be located adjacent the Fire Indicator Panel and will be linked to provide automatic initiation of warnings in the event of a fire alarm.

59. Security requirements, both physical and electronic, will be designed and installed taking cognisance of the Defence Security Manual and the Construction Security Reference Manual and in close liaison with the Defence Security Authority and other external agencies as may be required. When constructed, all electronic security will be integrated into the existing base security system. Inspection, certification and accreditation processes will be undertaken in accordance with the provisions of the Defence Security Manual.

OCCUPATIONAL HEALTH AND SAFETY

60. The removal of workplace congestion and OH&S risks are primary project objectives. The facilities to be provided will comply with the Department of Defence Occupational Health and Safety policy, the Occupational Health and Safety (Commonwealth Employment) Act 1991, Occupational Health and Safety (Commonwealth Employment) (National Standards) Regulation and the Northern Territory Codes of Practice.

LANDSCAPING

61. The existing base features practical landscaping with extensive stands of indigenous trees and shrubs. In the more built up and administrative areas of the base, judicious use of reticulated lawns along with native species provides an attractive and dust free environment in immediate proximity to appropriate buildings. The more remote facilities are generally located in cleared areas surrounded by natural bushland. Immediately around these facilities the soil is retained either by paving or dryland native grasses. These characteristics of the existing base will be maintained and continued as relevant to the proposed works.

INDUSTRY AND COMMUNITY IMPACTS

62. Over the planned construction period of 25 months, an average of some 90 personnel is expected to be directly employed on construction activities. Additional employment will be associated with off-site prefabrication and supply activities associated with the project. As the works generally involve the replacement or refurbishment of existing facilities, it is not expected that the project will generate any significant ongoing employment opportunities.

63. The project is likely to generate additional traffic in the industrial areas of Katherine and on the highway between Katherine and Tindal during the construction period. It is not expected that there would be any other significant impacts on the Katherine community either during or after the construction period.

PROJECT COSTS

64. The estimated capital cost of the project is \$58.7m plus GST in out-turn prices (excluding GST). This includes preliminaries, construction and fitout costs, professional fees, furniture and fittings, information technology equipment, and contingency provisions.

PROJECT DELIVERY SYSTEM

65. The proposed method of delivery is by Managing Contractor. The flexibility of this contracting method allows greater opportunities in mitigating cost escalation risk by allowing the contractor to manage the work elements within the project program. This delivery method also ensures disruption to the Base can be minimised.

CONSTRUCTION TIMEFRAME

66. Subject to Parliamentary clearance, it is planned to commence construction in mid 2009, with planned completion in late 2011.

ANNEXES

A. Location Plan

B. Base Layout Plan

C. Site Plan Proposed Facilities

C-1 West Side

C-2 East Side

D. Concept Sketch Plans

D-1 Security Fence Extensions

D-2 Central Emergency Power Station

D-3 Ordnance Loading Apron Water Supply

D-4 Liquid Dry Breathing Oxygen Facility

D-5 Aircraft Maintenance Annexes

D-6 Inflights and Surge Catering

D-7 Ordnance Loading Apron Security

D-8 Tanker Maintenance and Refuelling Facilities

D-9 Fire Station

D-10 Supply Services Warehouse

D-11 Messing Improvements

D-12 Passenger Terminal

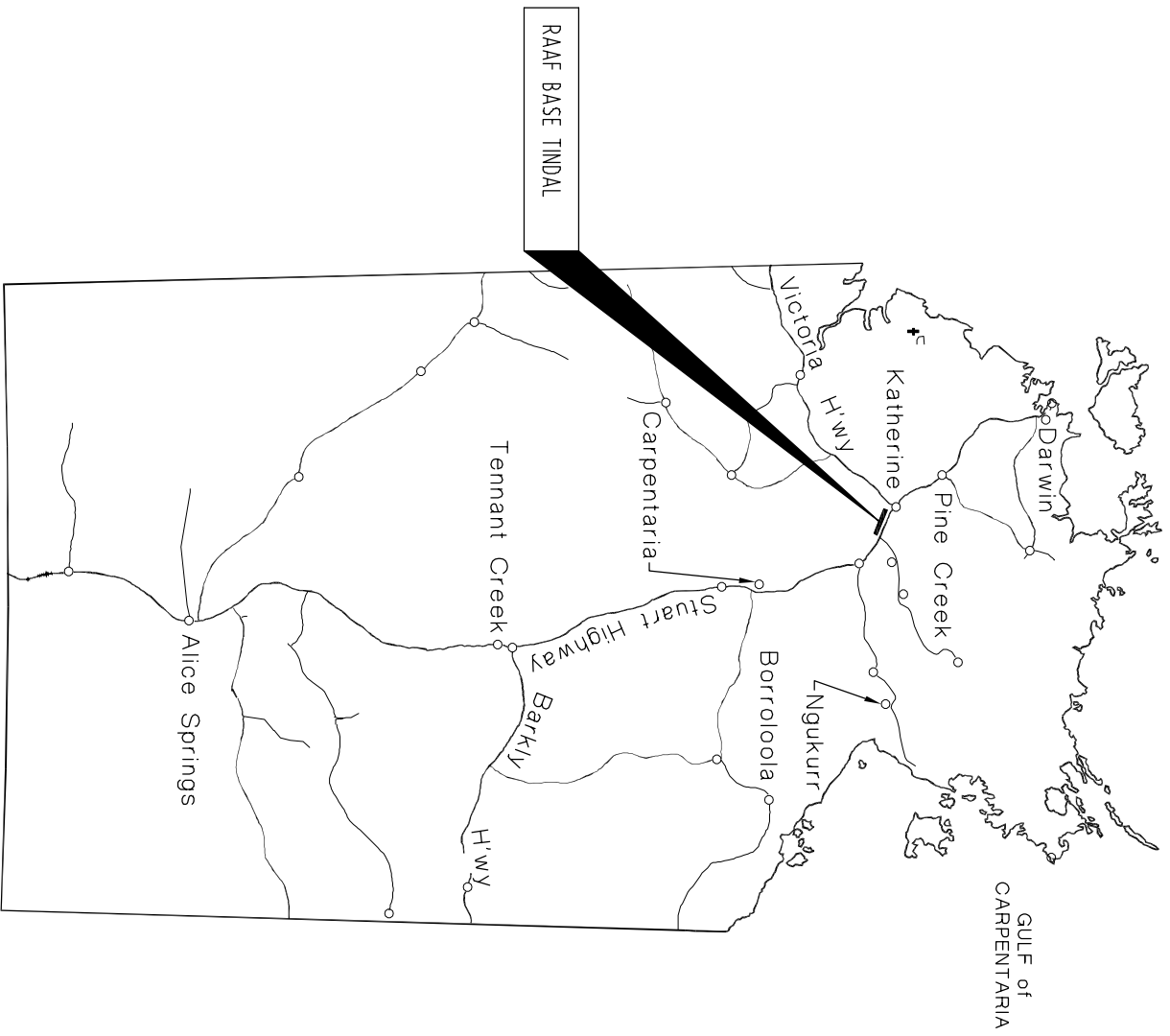

RAAF BASE TINDAL
REDEVELOPMENT STAGE 5

LOCATION PLAN

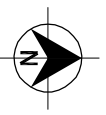

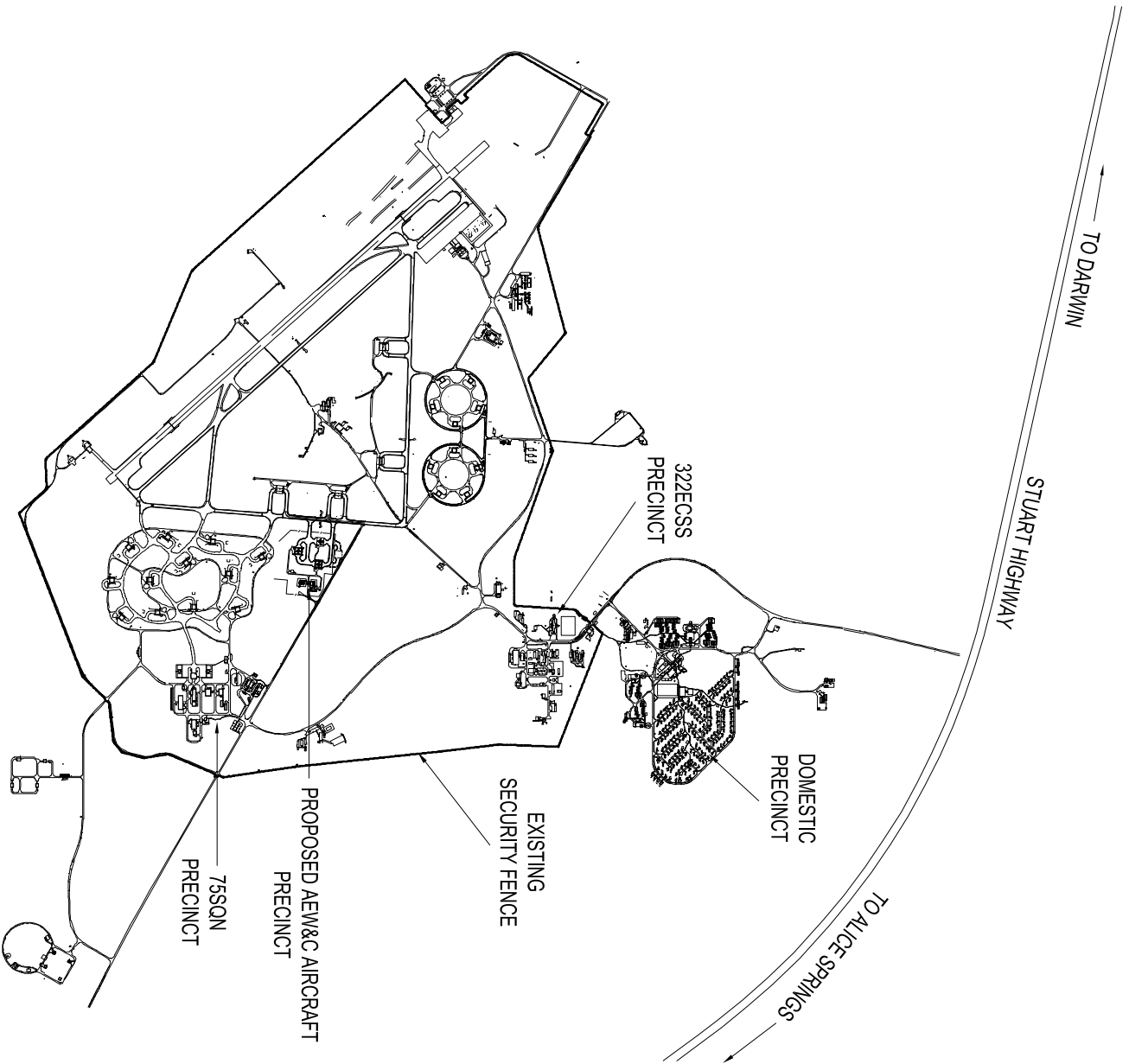

**RAAF BASE TINDAL
REDEVELOPMENT STAGE 5**

**BASE LAYOUT
PLAN**



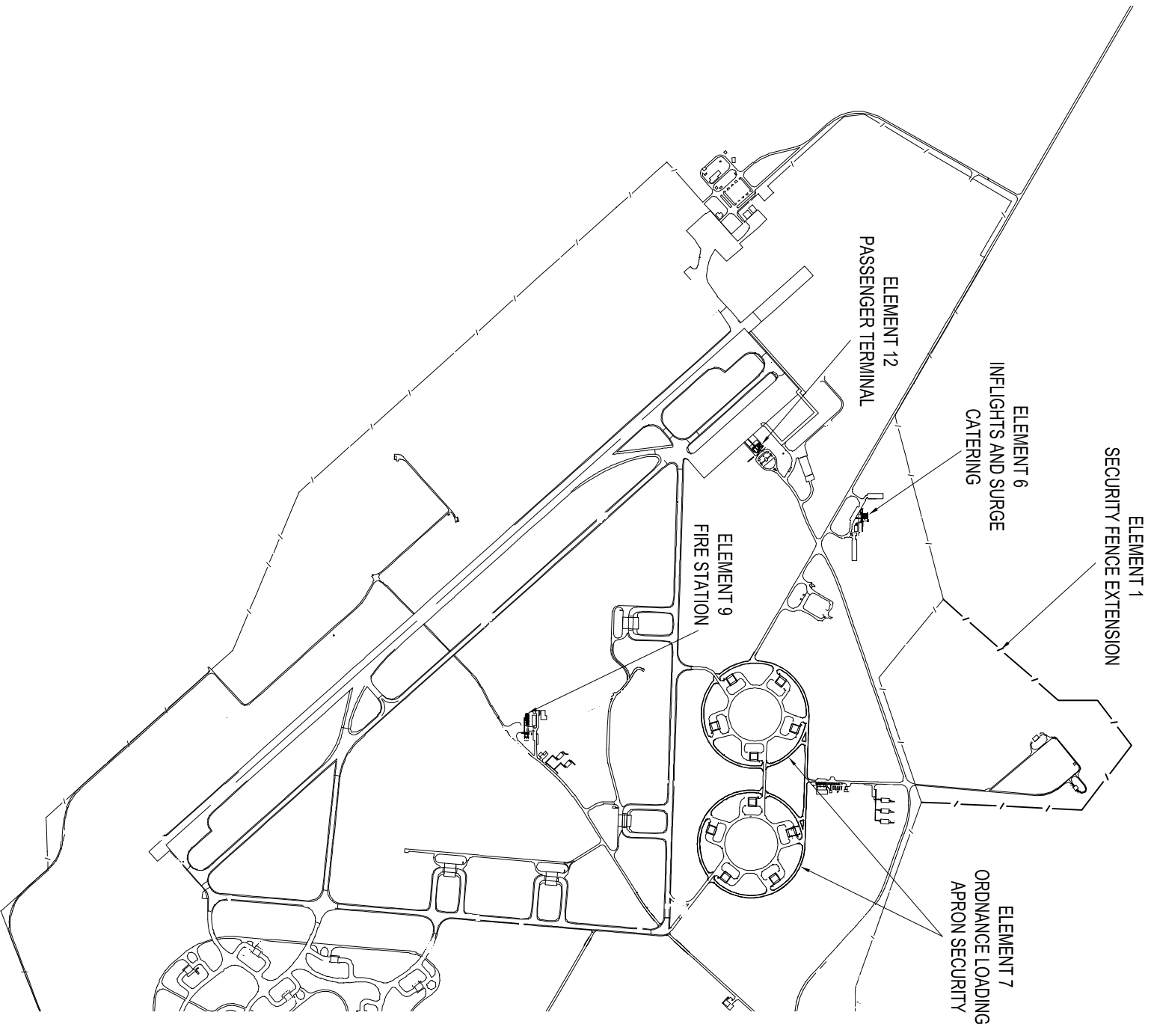

**RAAF BASE TINDAL
REDEVELOPMENT STAGE 5**

**SITE PLAN OF PROPOSED
FACILITIES
(WEST SIDE)**

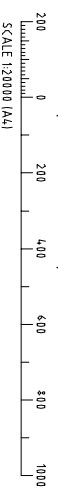

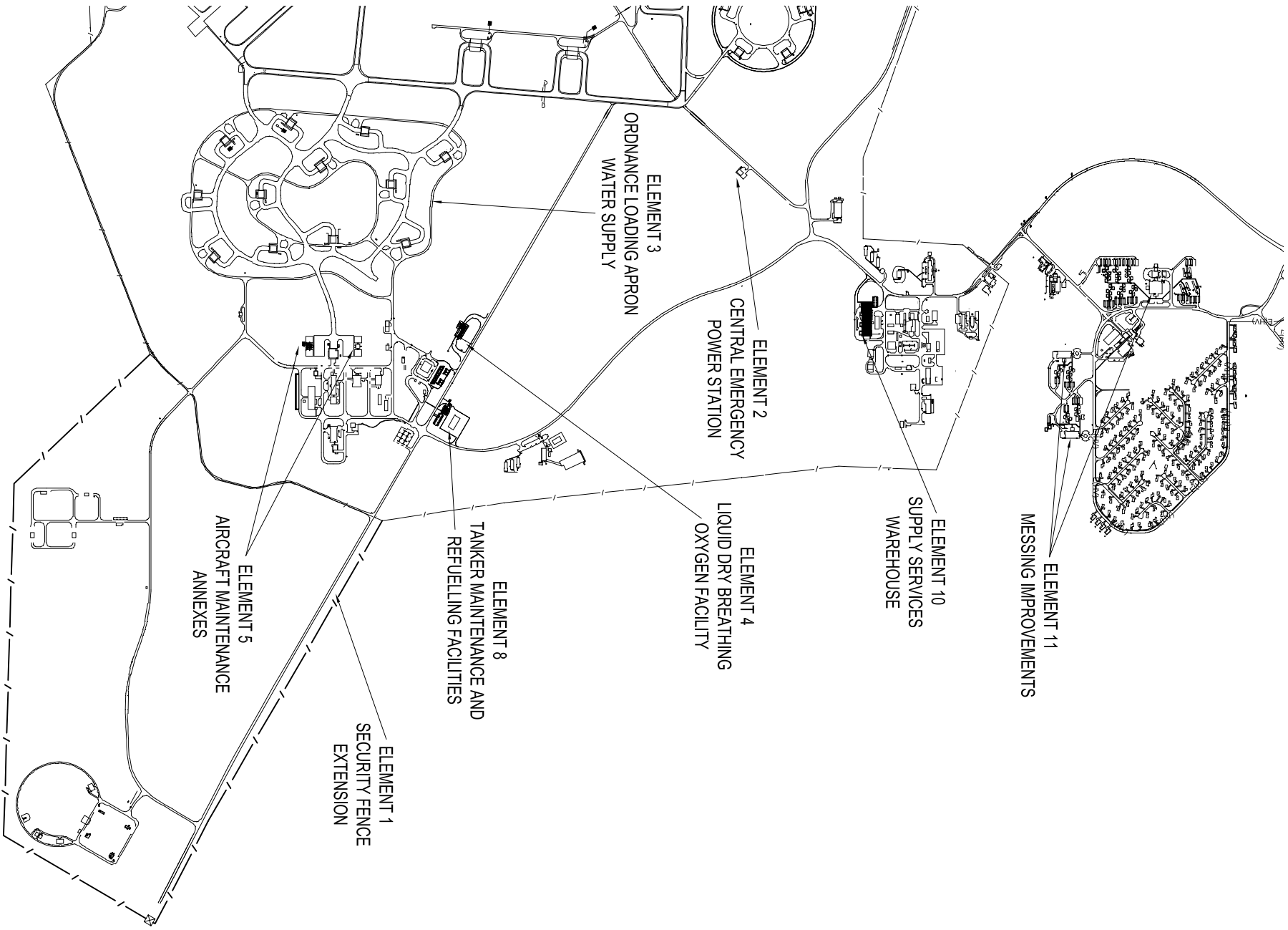

**RAAF BASE TINDAL
REDEVELOPMENT STAGE 5**

**SITE PLAN OF
PROPOSED FACILITIES
(EAST SIDE)**

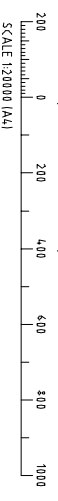

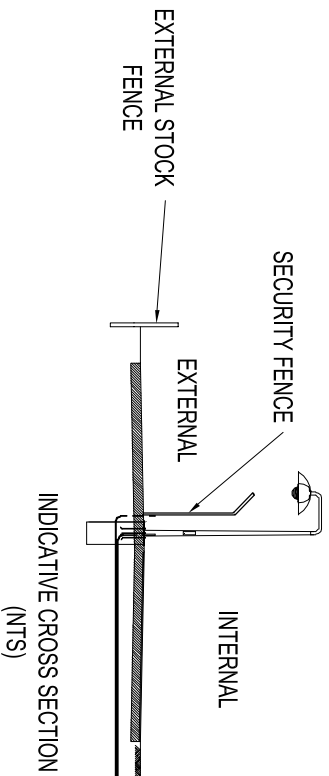
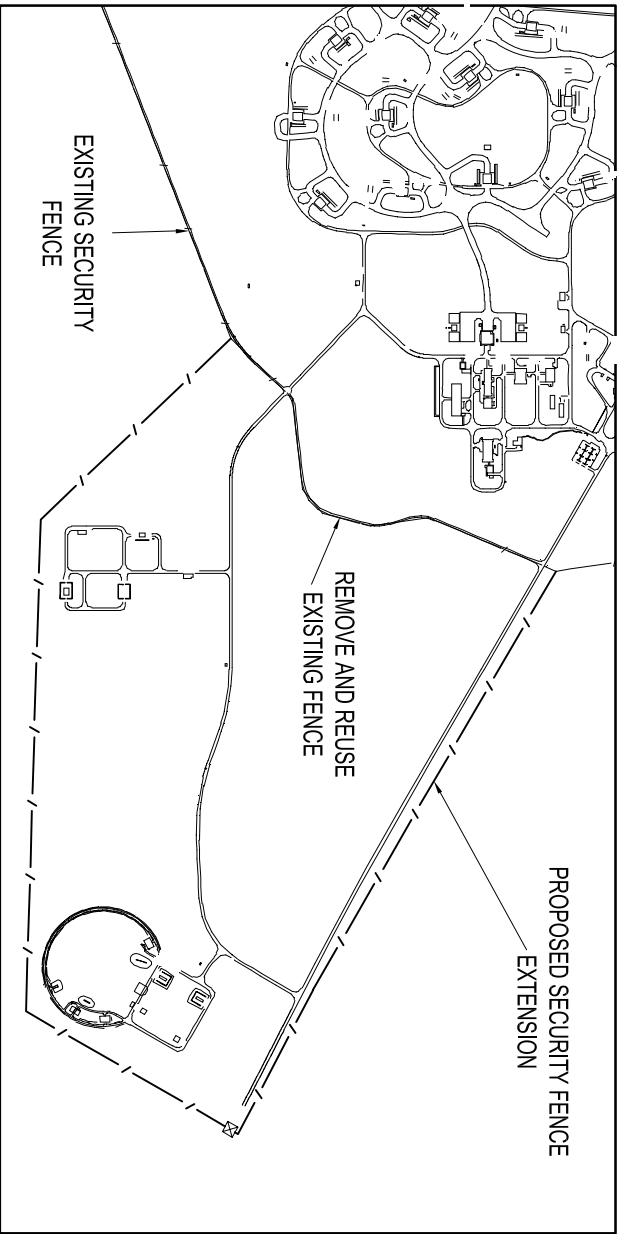
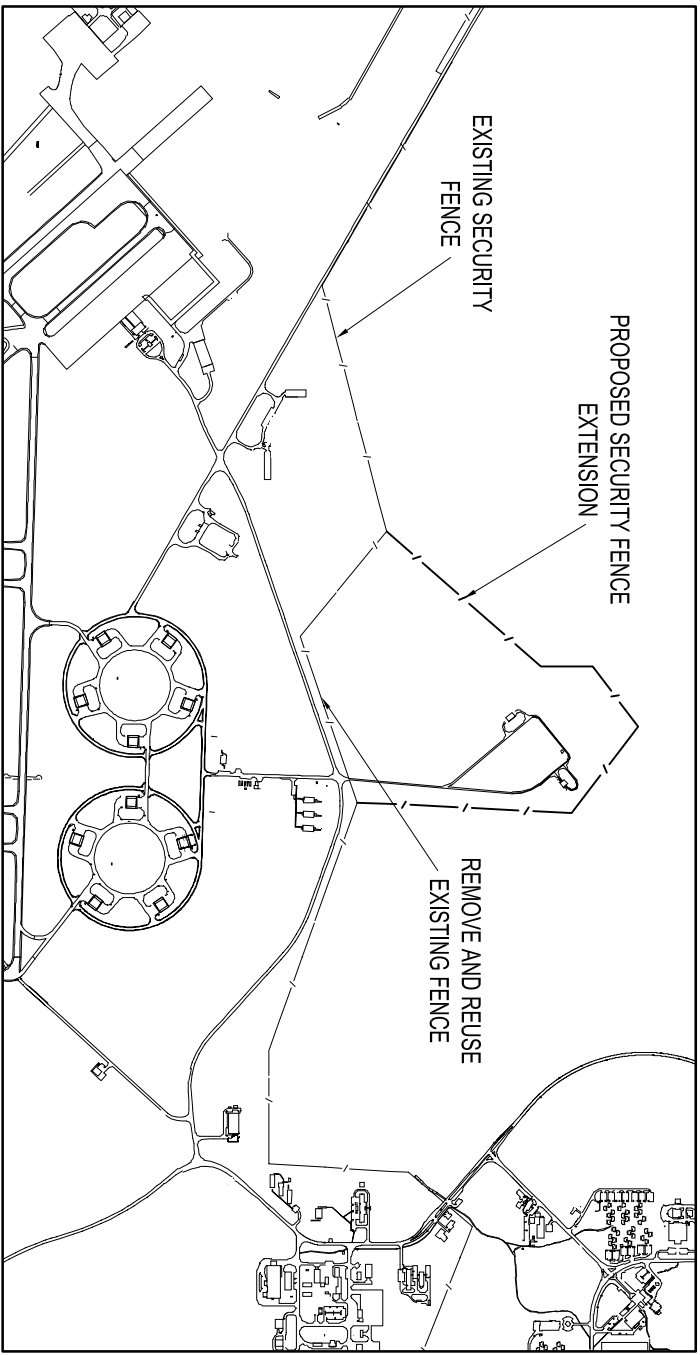

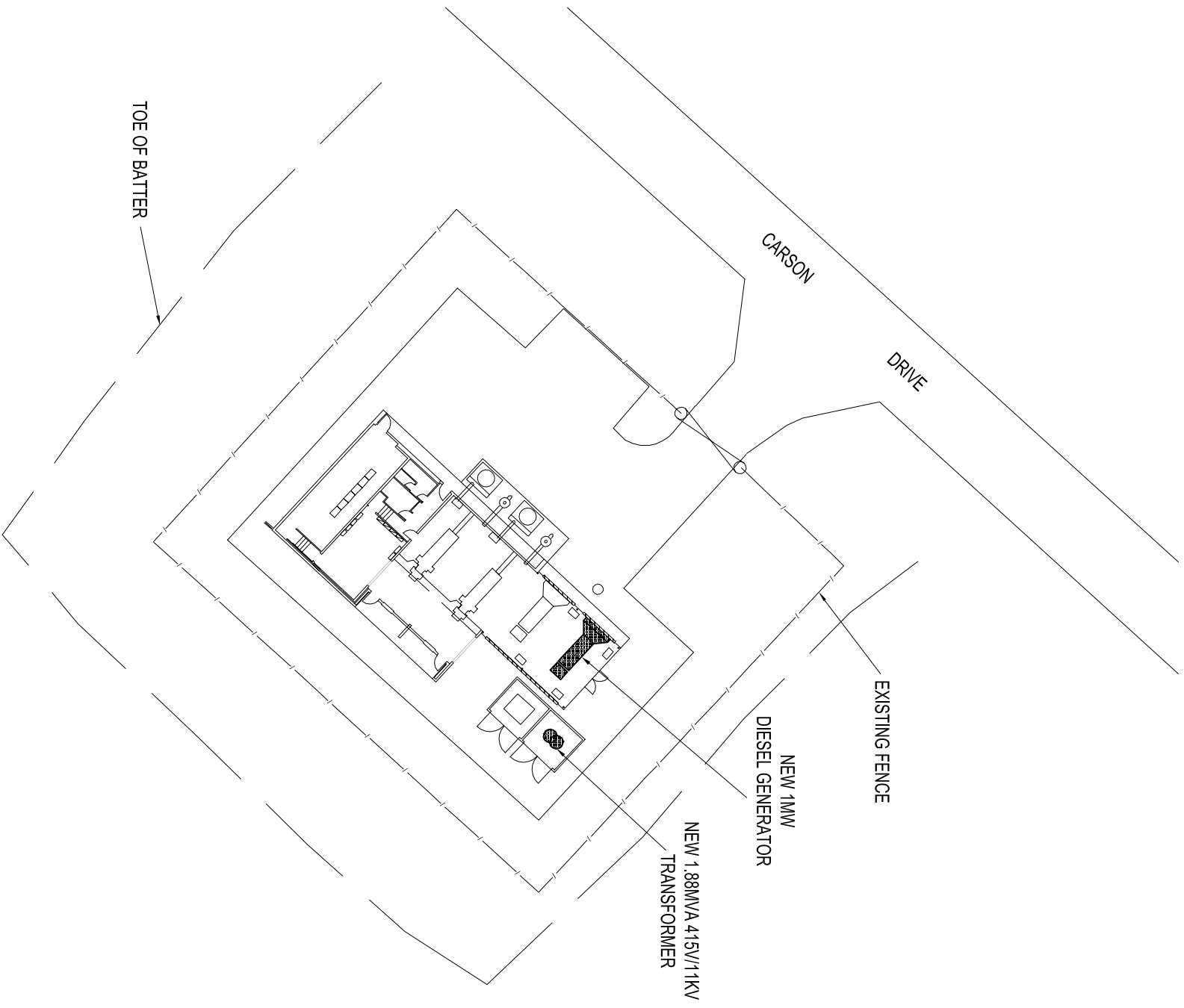

RAAF BASE TINDAL
REDEVELOPMENT STAGE 5

CENTRAL EMERGENCY
POWER STATION



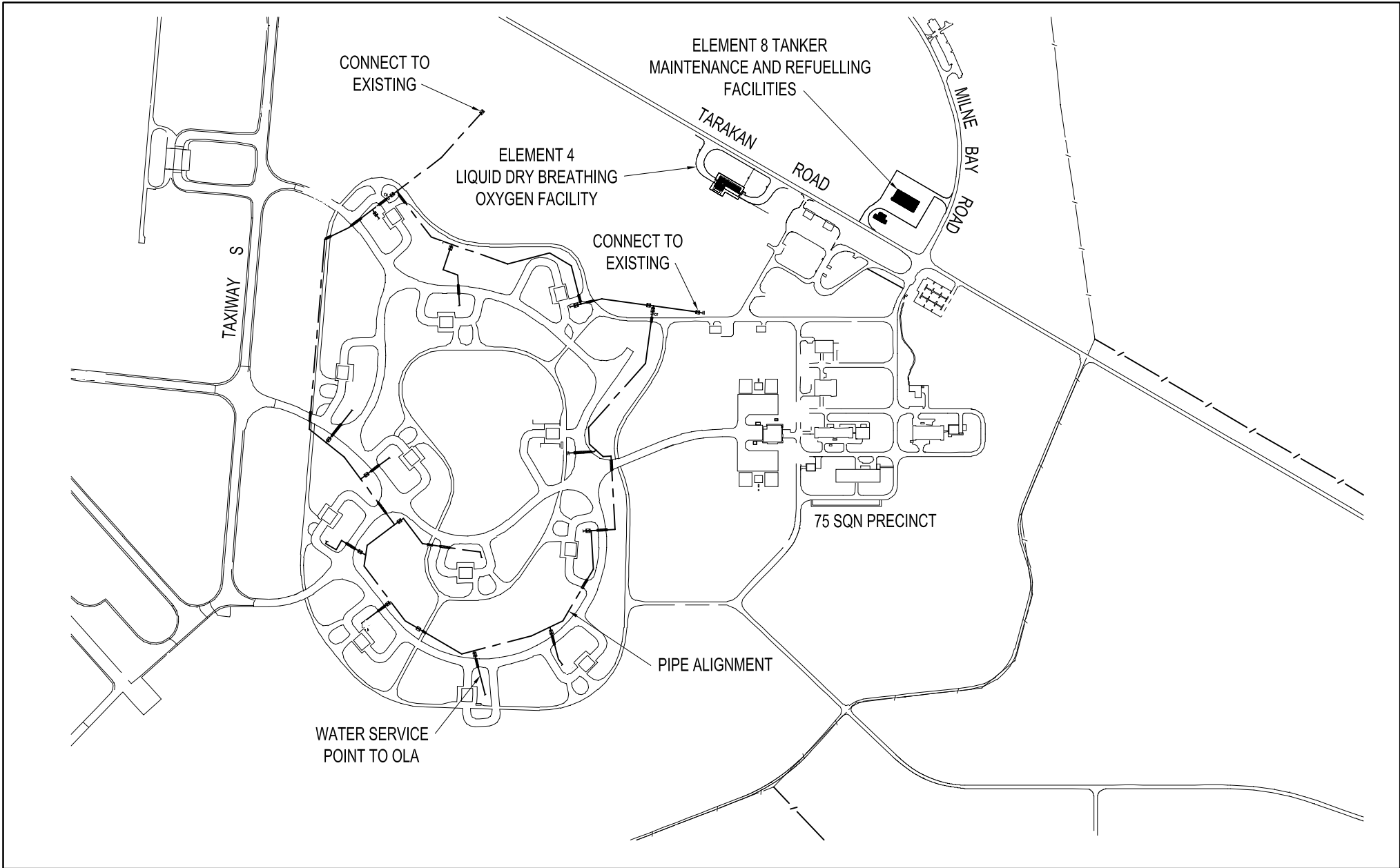

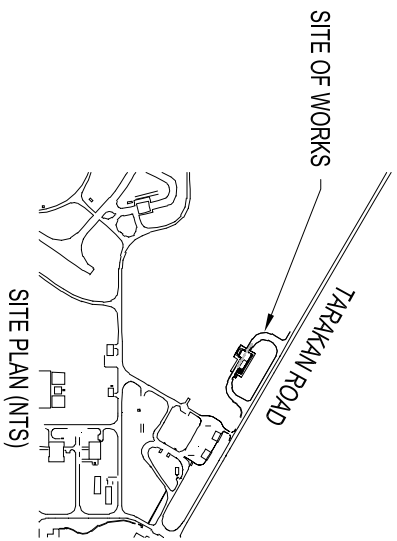

LEGEND	
ROOM No	ROOM NAME
01	518 GAL LD80 CART STORAGE AREA
02	COVERED AREA (LOWER ROOF)
03	UNISEX TOILET
04	UNISEX SHOWER
05	FEMALE CHANGE ROOM
06	MALE CHANGE ROOM
07	STORE
08	CARPARK
09	EVAPORATION PIT

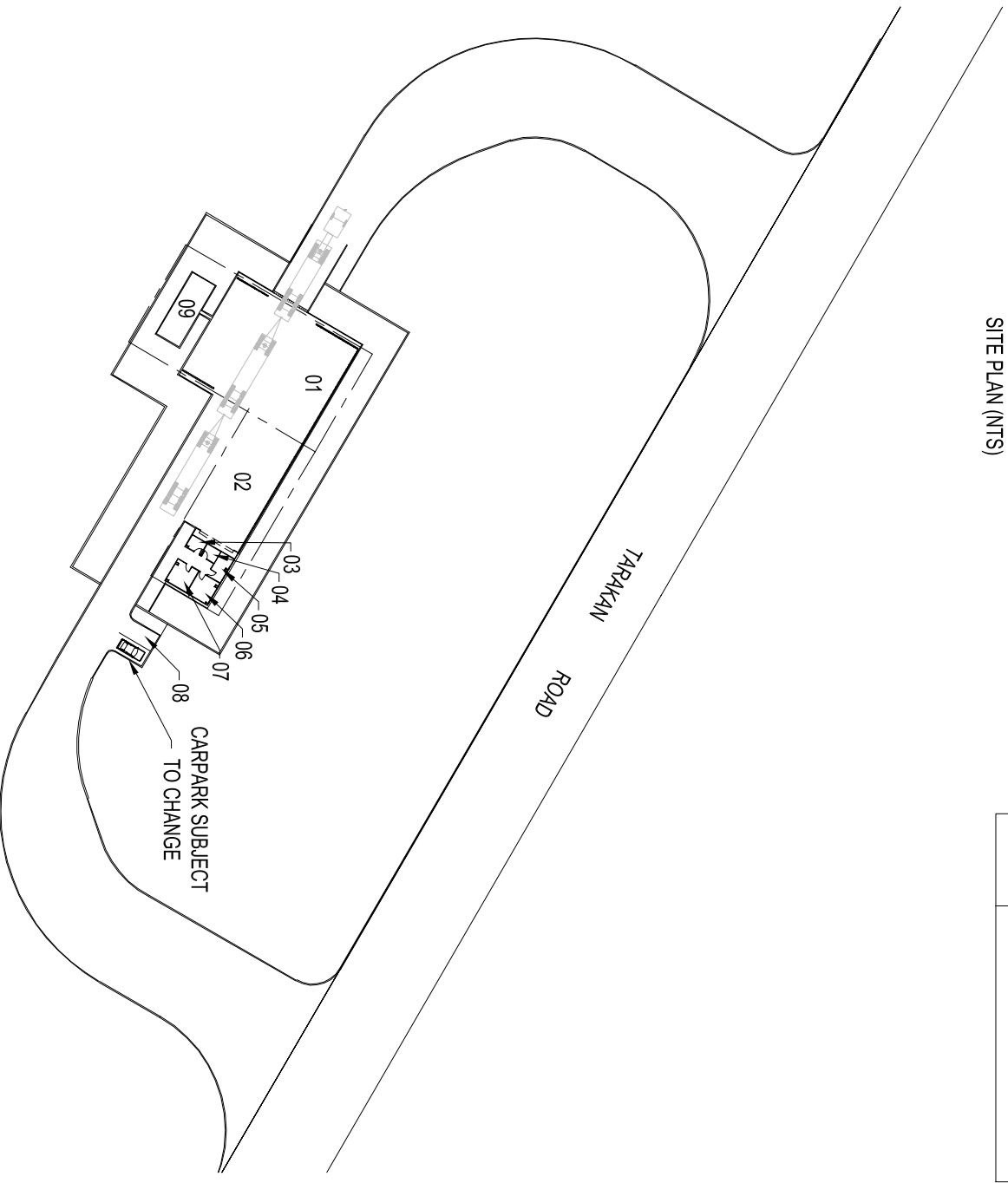

LEGEND	
ROOM No	ROOM NAME
01	EXISTING COVERED CARPARK
02	CREW ROOM/KITCHENETTE/BRIFING ROOM
03	PLANT ROOM
04	SECT COORD
05	MSI STORE
06	FLSGT
07	4 SMO'S OFFICE
08	COMPUTERS PUBLICATIONS
09	HANGAR
10	HANGAR
11	MALE ABLUTION
12	FEMALE ABLUTION
13	EXISTING SUBSTATION

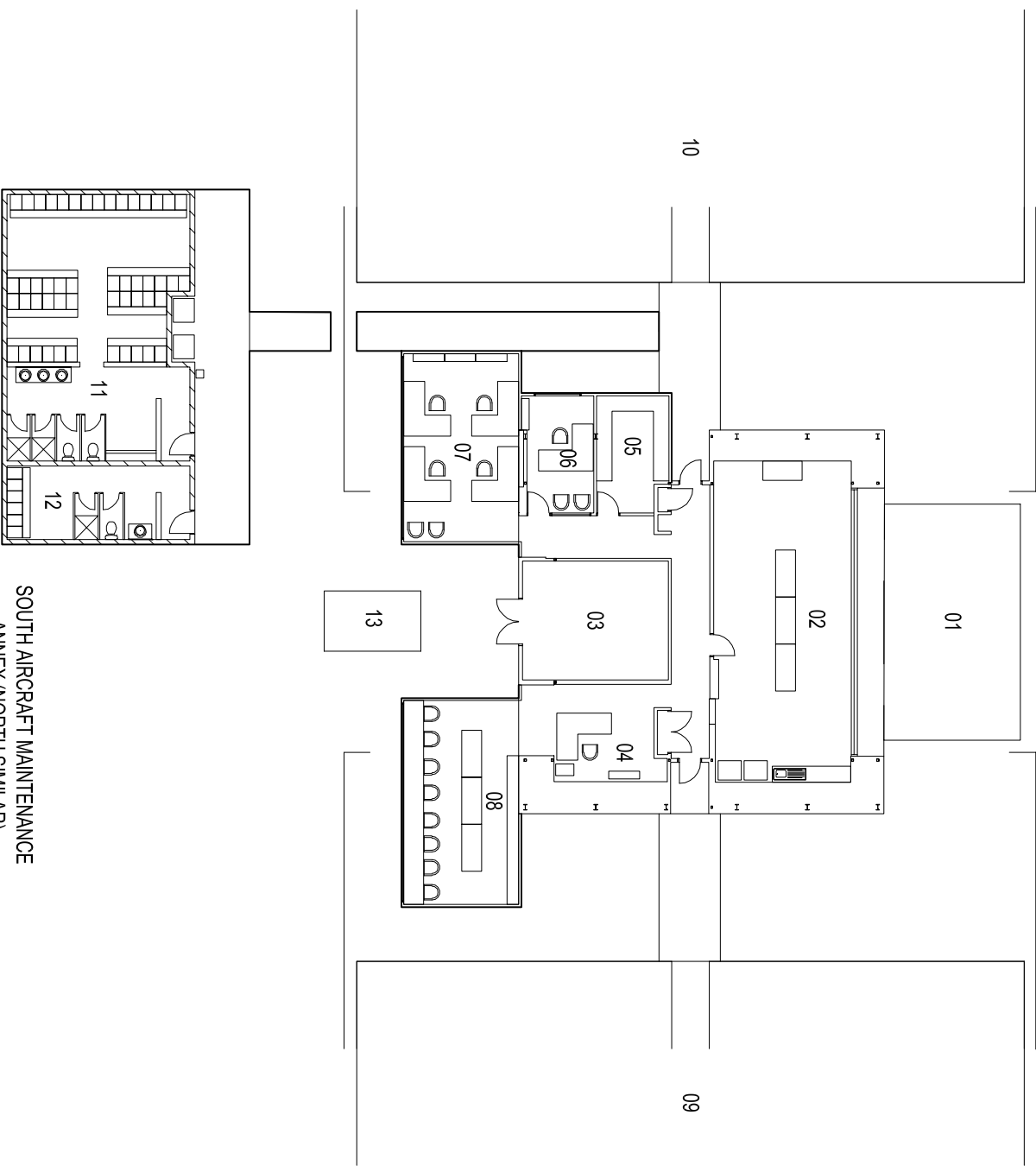
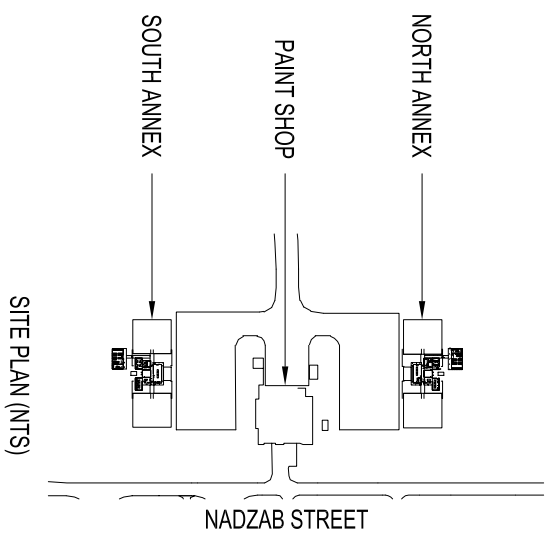

SOUTH AIRCRAFT MAINTENANCE
ANNEX (NORTH SIMILAR)



Australian Government
Department of Defence
Defence Support Group

RAAF BASE TINDAL
REDEVELOPMENT STAGE 5

AIRCRAFT MAINTENANCE
ANNEXES

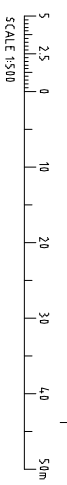

LEGEND	
ROOM No	ROOM NAME
01	INFLIGHT PACKAGING
02	TROLLEY
03	MINOR COOKING
04	MALE ABLUTION
05	FEMALE ABLUTION/DISABLED
06	CLEANERS
07	DISH AND POT WASH
08	FREEZER
09	THAW LOBBY
10	MEAT COOLROOM
11	GENERAL COOL ROOM
12	INFLIGHTS PREP KITCHEN
13	KITCHEN MESS
14	MESS SERVERY
15	DINING ROOM
16	EXTERNAL PLANT
17	FINISHED FOOD FREEZER
18	INFLIGHTS OUTWARDS
19	DRY STORE
20	GOODS RECEIVING
21	COMMUNICATIONS ROOM
22	GAS STORE
23	OFFICE
24	PLANT ROOM

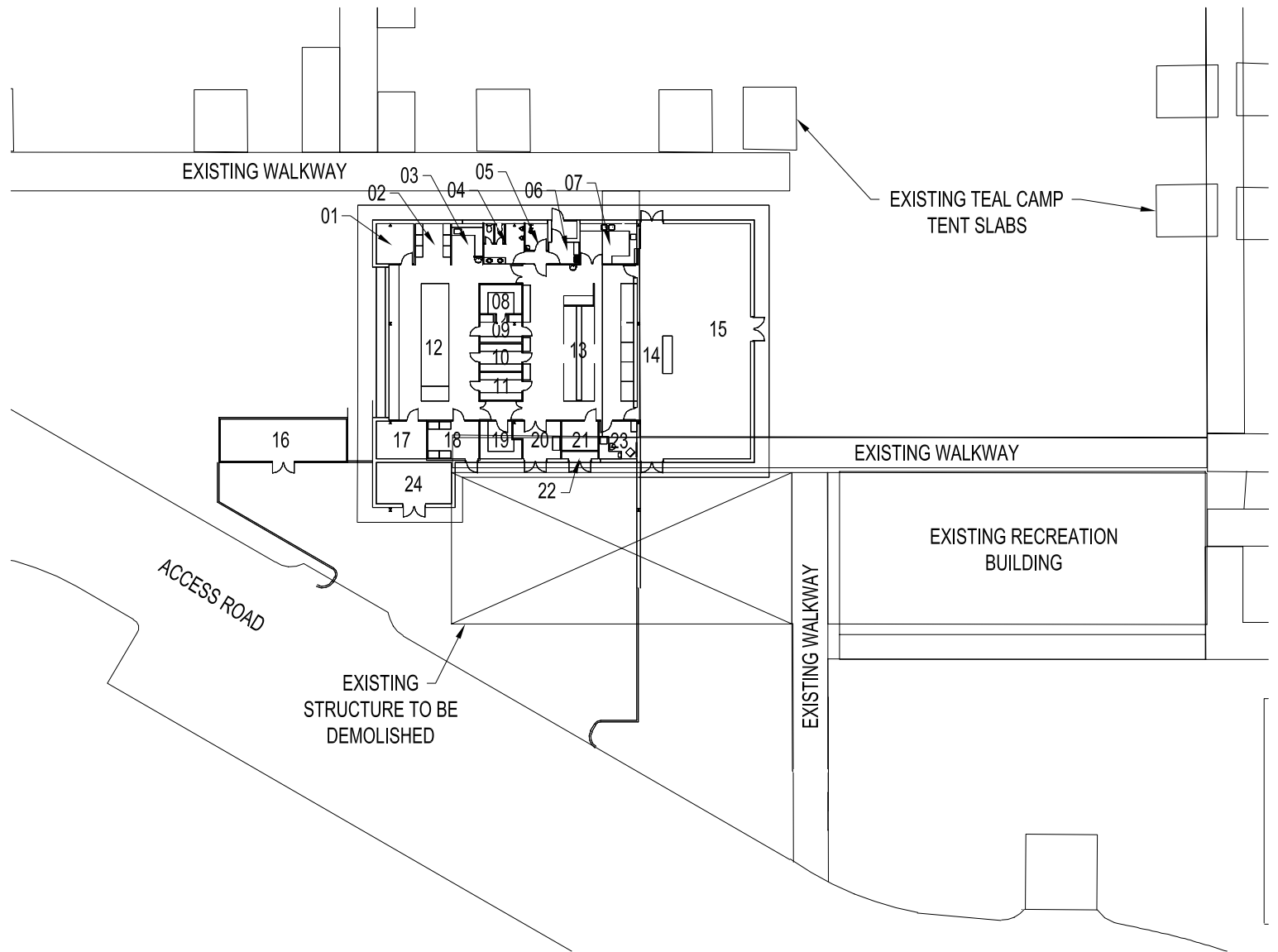

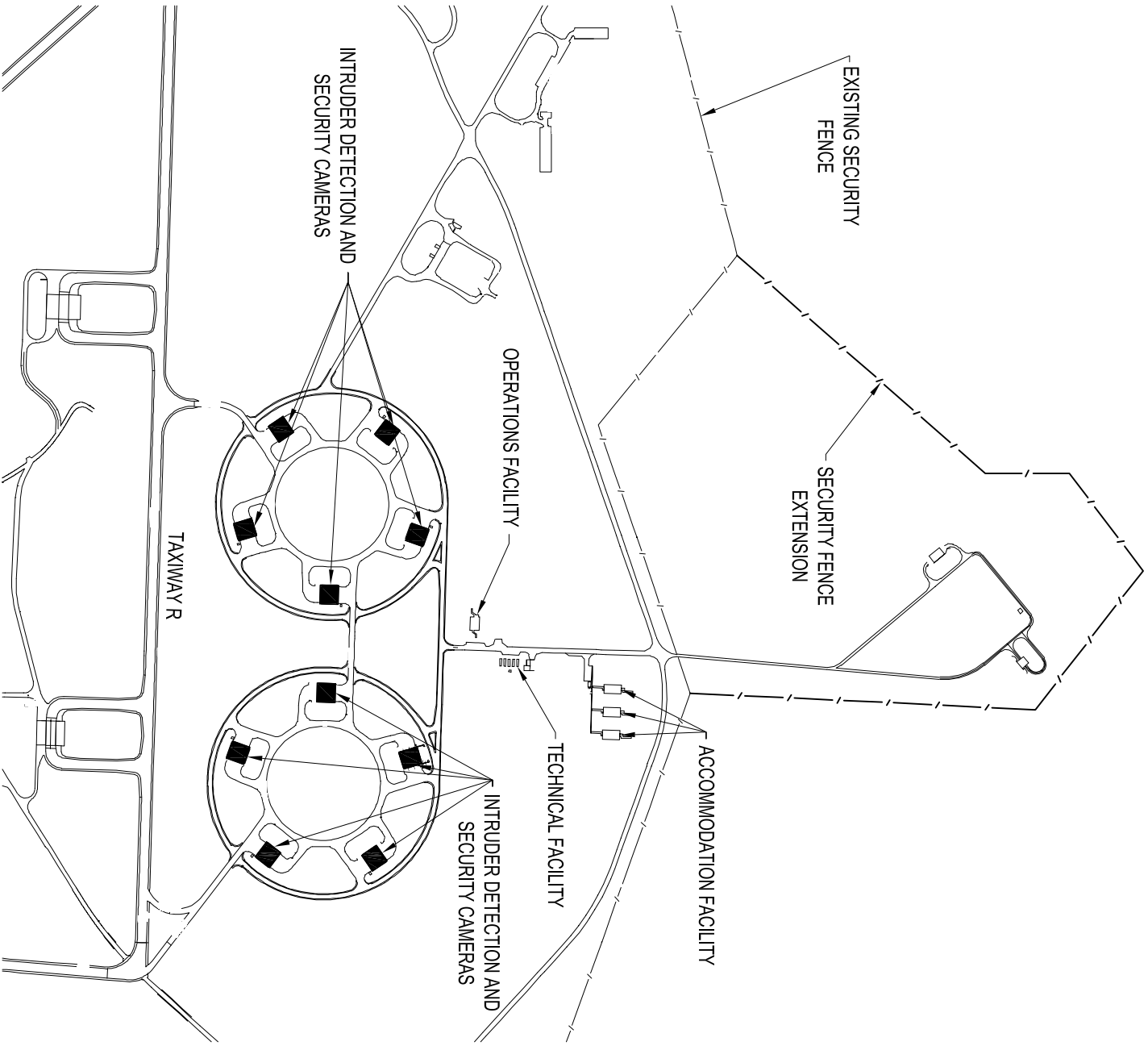

**RAAF BASE TINDAL
REDEVELOPMENT STAGE 5**

**ORDNANCE LOADING
APRON SECURITY**

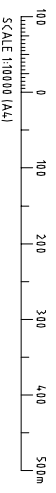

LEGEND	
ROOM No	ROOM NAME
01	SMALL REPAIRS WORKSHOP
02	UNISEX TOILET
03	AIR LOCK
04	COMMS ROOM
05	HOSES STORE
06	COMPUTER ROOM
07	MEOMS STORE
08	ENCLOSED WIDE MAINTENANCE BAY
09	ENCLOSED MAINTENANCE BAY
10	OPEN MAINTENANCE BAY
11	OPEN MAINTENANCE BAY
12	WASH BAY
13	OFFICE
14	LABORATORY
15	DRIVERS SNCO
16	DRIVERS CPL'S
17	TRAINING ROOM
18	CREW ROOM
19	COMMUNICATIONS ROOM
20	PLANT ROOM
21	MEOMS SNCO
22	MEOMS CPL'S
23	MALE CHANGE
24	MALE ABLUTION
25	LAUNDRY/IRONING
26	CLEANERS ROOM
27	FEMALE ABLUTION

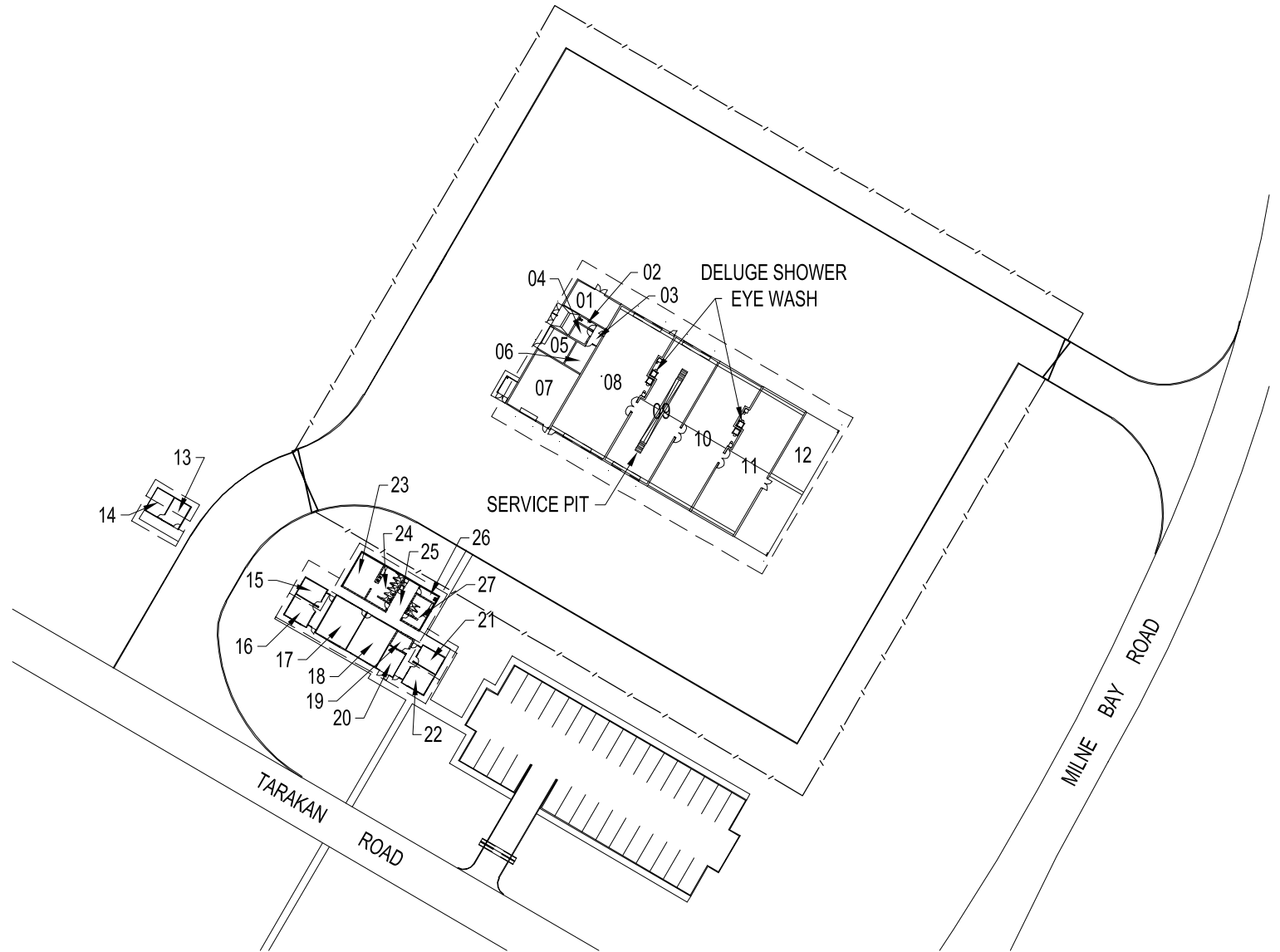

LEGEND	
ROOM No	ROOM NAME
01	MALE CHANGE ROOM
02	MALE ABLUTION/SHOWER/LAUNDRY
03	SLEEPING ROOM
04	PLANT ROOM
05	CARPARK
06	WASTE CLOSET
07	WATCH ROOM
08	CLEANERS
09	FLSGT
10	FEMALE ABLUTION/SHOWER/LAUNDRY
11	TRAINING ROOM
12	NEW CPL'S OFFICE
13	SNCO'S
14	CREW ROOM
15	EXISTING CAR PARKING
16	SIMULATOR TRAINING ROOM
17	WORKSHOP
18	BREATHING APPARATUS ROOM
19	MAIN STORE
20	PUMPS AND GENERATOR STORE
21	BREATHING APPARATUS STORE

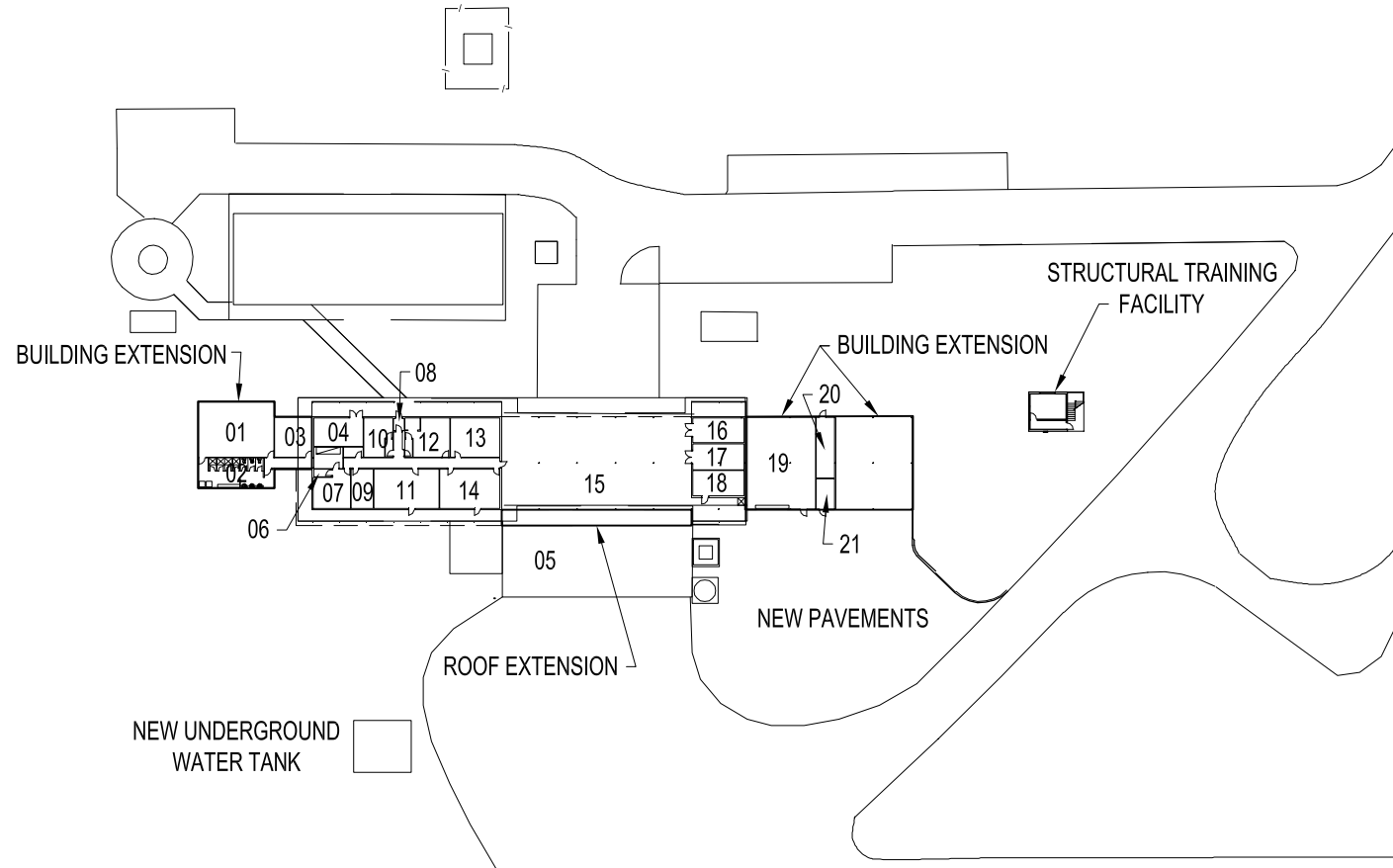

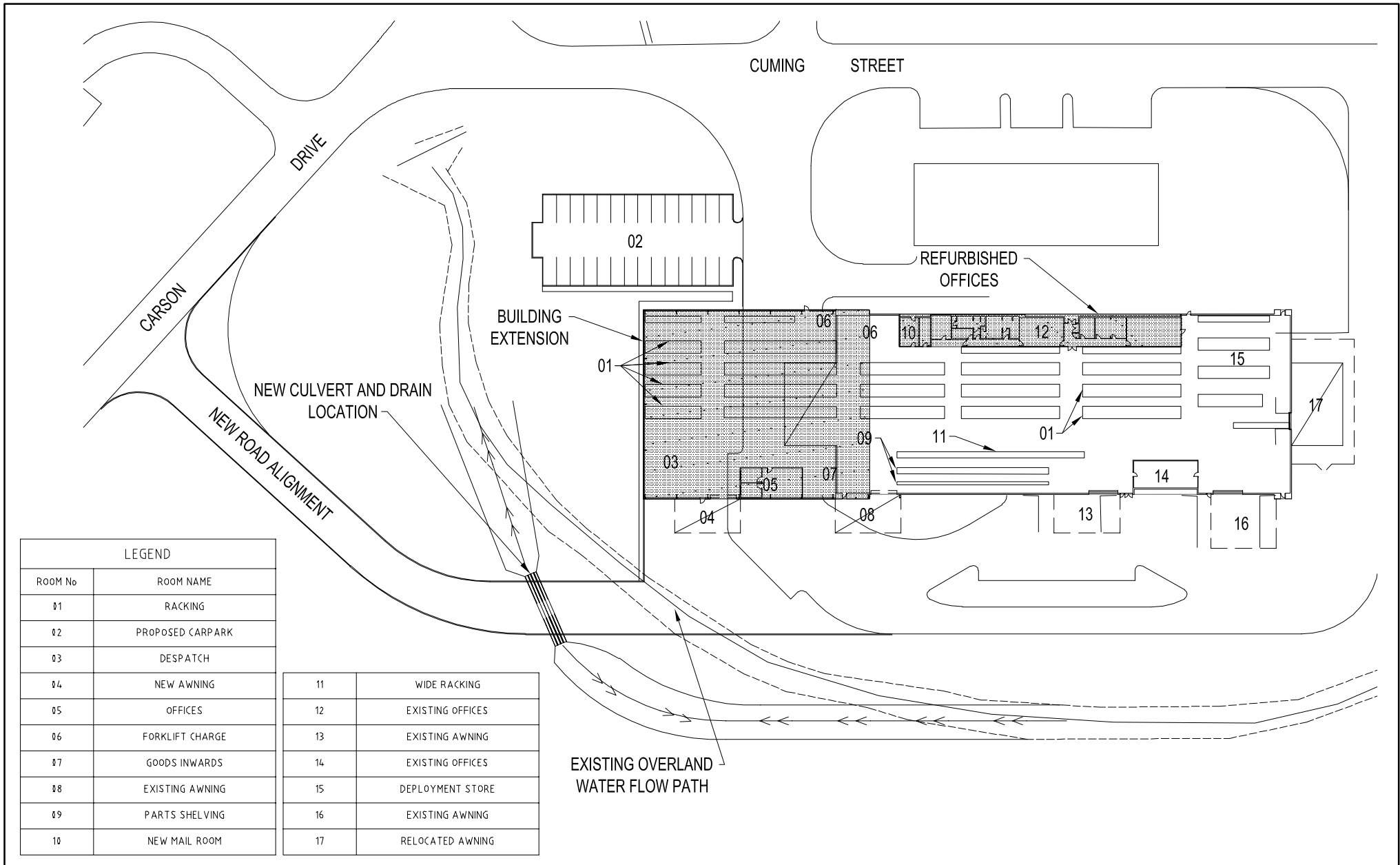

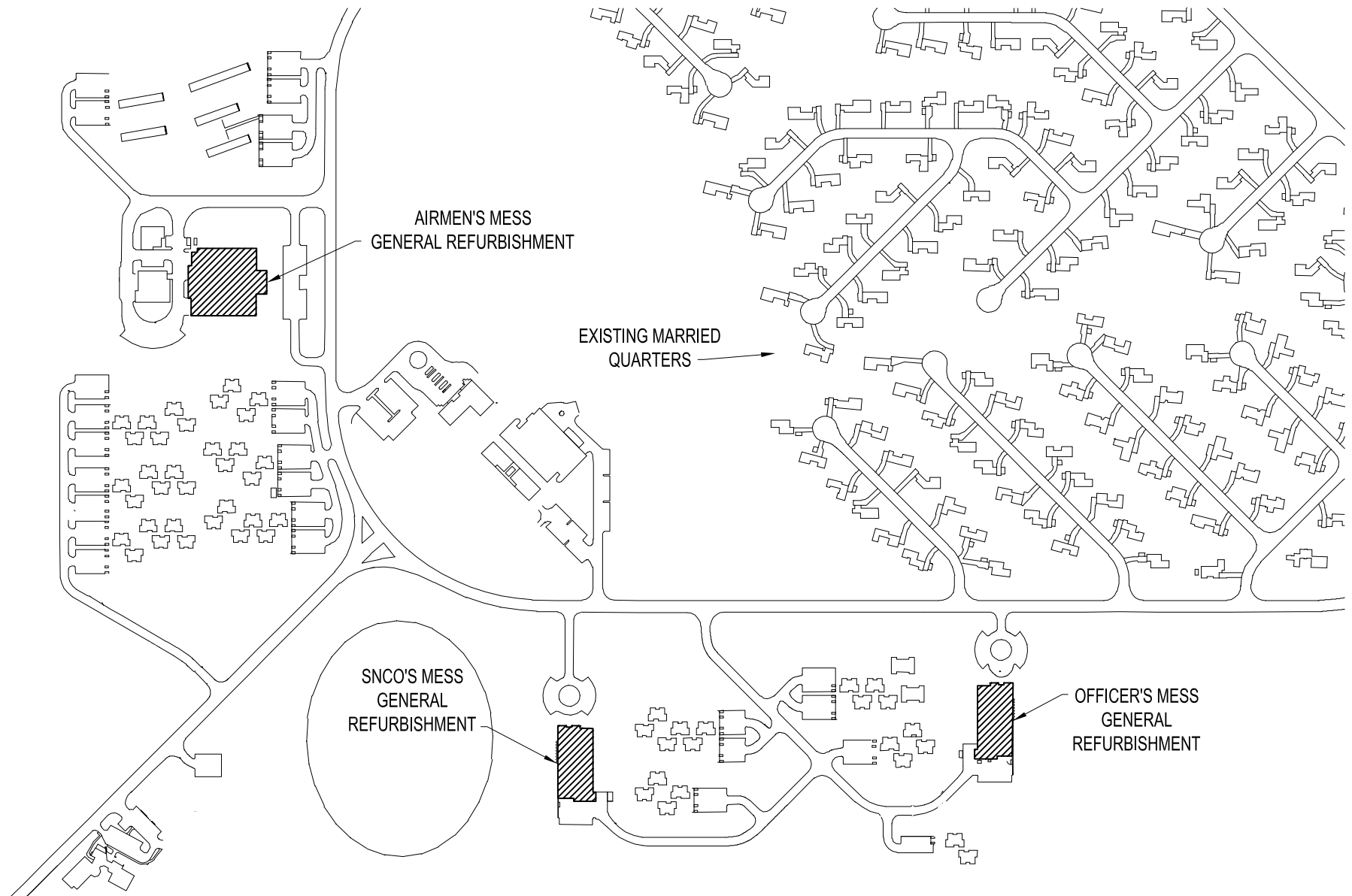

LEGEND	
ROOM No	ROOM NAME
01	BAGGAGE COLLECTION
02	NEW CARPORT
03	BAGGAGE ARRIVAL
04	FEMALE ABULTION
05	MALE ABULTION
06	NEW SHADE STRUCTURE
07	EXISTING WAITING LOUNGE
08	NEW WAITING LOUNGE
09	VERANDAH
10	NEW SHADE STRUCTURE
11	NEW SHADE STRUCTURE
12	ENTRY/EXIT

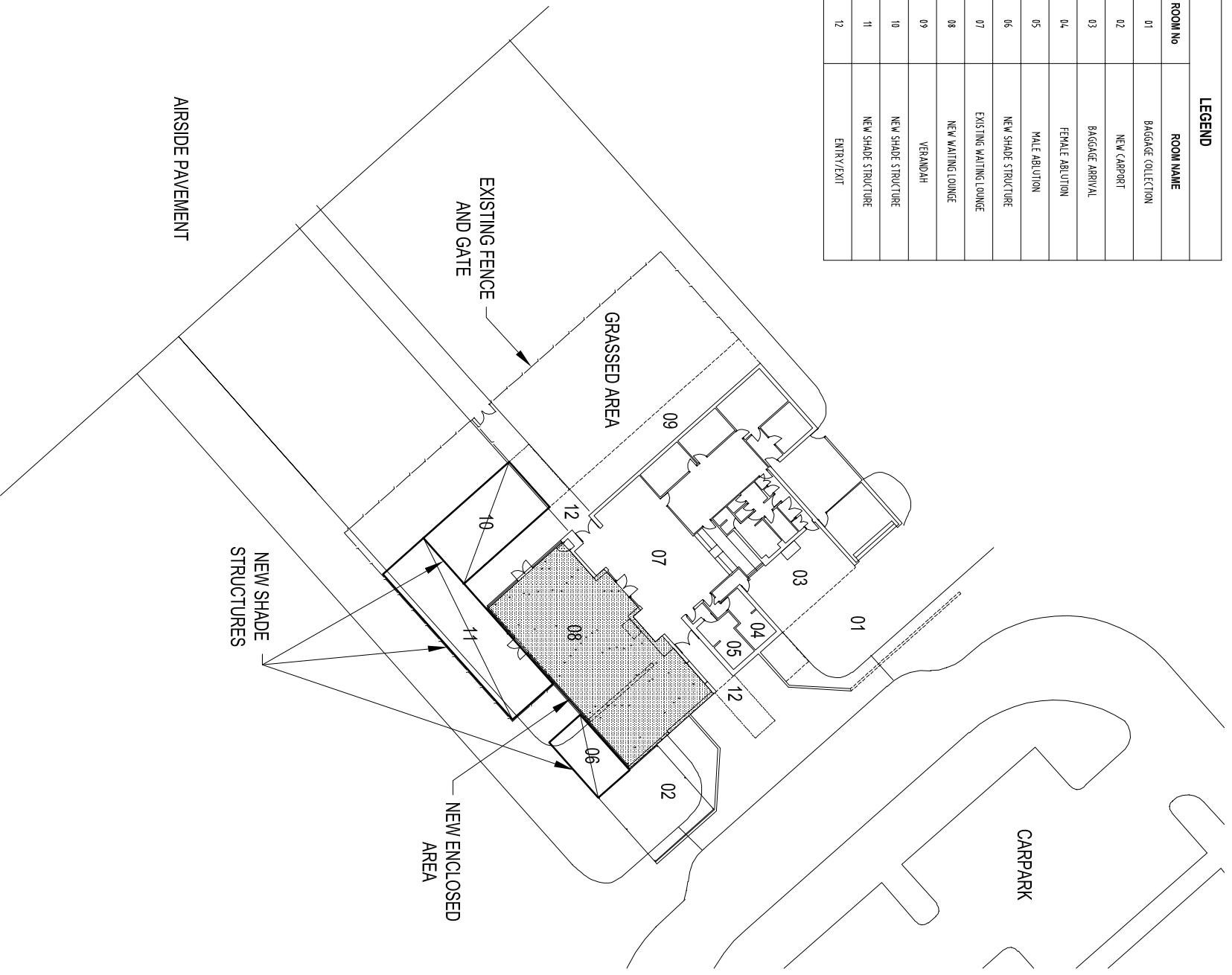

RAAF BASE TINDAL
REDEVELOPMENT STAGE 5

PASSENGER
TERMINAL

