



Going digital—digital terrestrial radio for Australia

Dr Rhonda Jolly
Social Policy Section

Executive summary

- Since the early 20th century radio has been an important source of information and entertainment for people of various ages and backgrounds.
- Almost every Australian home and car has at least one radio and most Australians listen to radio regularly.
- The introduction of new radio technology—digital terrestrial radio—which can deliver a better listening experience for audiences, therefore has the potential to influence people's lives significantly.
- Digital radio in a variety of technological formats has been established in a number of countries for some years, but it is expected only to become a reality in Australia sometime in 2009.
- Unlike the idea of digital television however, digital radio has not fully captured the imagination of audiences and in some markets there are suggestions that it is no longer relevant.
- This paper provides a simple explanation of the major digital radio standards and a brief history of their development. It particularly examines the standard chosen for Australia, the Eureka 147 standard (known also as Digital Audio Broadcasting or DAB).
- The paper also traces the development of digital radio policy in Australia and considers issues which may affect the future of the technology.

Contents

| | |
|--|----|
| Introduction..... | 1 |
| Radio basics: AM and FM radio..... | 3 |
| How do AM and FM work?..... | 3 |
| How AM radio works..... | 4 |
| FM: superior sound quality..... | 4 |
| Digital radio..... | 6 |
| Definition..... | 6 |
| Benefits of digital radio..... | 6 |
| Development of digital radio..... | 7 |
| Digital Audio Broadcasting: DAB..... | 8 |
| Country development..... | 9 |
| Development of other digital radio systems..... | 12 |
| Digital Radio Mondiale: DRM..... | 12 |
| Hybrid Digital (HD) or In-Band On-Channel (IBOC)..... | 13 |
| Other terrestrial digital standards..... | 14 |
| Digital Video Broadcasting–Terrestrial (DVB–T)..... | 14 |
| Terrestrial Integrated Services Digital Broadcasting (ISDB–T)..... | 14 |
| Digital radio for Australia..... | 15 |
| Policy development and implementation..... | 15 |
| Step 1: investigation..... | 15 |
| Digital radio trials..... | 16 |
| Step 2: discussion and more discussion..... | 17 |
| Narrowband..... | 21 |
| Step 3: the digital framework..... | 21 |
| Step 4: legislation..... | 23 |
| Step 5: new government–same plans..... | 24 |
| The Future of Digital Radio..... | 24 |
| Overseas..... | 24 |
| Britain..... | 24 |
| Canada..... | 27 |
| United States..... | 28 |
| Australia..... | 29 |
| The question of interest..... | 29 |
| Technology uncertainties..... | 31 |
| How will community broadcasting fare?..... | 33 |
| Conclusion..... | 36 |
| Glossary..... | 37 |

Introduction

For most of the twentieth century radio has played important and varied roles in people's lives. According to one study, and as the diagram below illustrates:

Radio is everywhere. It wakes us up in the morning and accompanies us around the house—in the bedroom, in the shower, in the kitchen—entertaining and informing us. It helps us get to work, advising us of traffic problems and calming our nerves as we commute, in the car or on public transport. For some of us, it keeps us going through the day, either at work or at home, providing company, entertaining us and making us think. At the end of the working day it helps us get home again.¹

In effect, it is argued that radio provides some people with company, it is an interactive tool for others; it can alleviate the boredom of monotonous work and most importantly, it is 'an important connection with the outside world'.²

Purposes and characteristics of radio

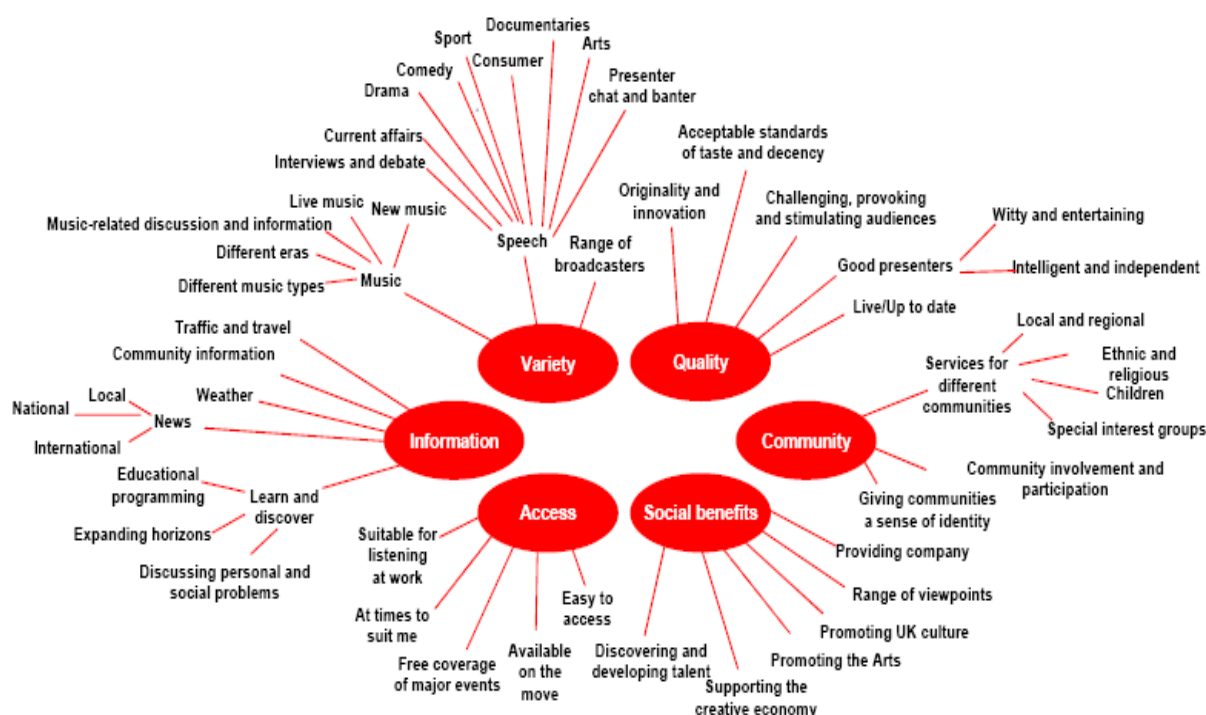

Source: Mori study for Ofcom³

There is significant evidence to affirm these claims. In Australia for example, there are more than 37 million radios and a significant majority of Australians listen to radio regularly.⁴

1. Study by Mori, *Radio. Preparing for the future*, Office of Communications (Ofcom). Result of consultation 2005, http://www.ofcom.org.uk/consult/condocs/radio_review/radio_review2/ accessed on 21 January 2008.

2. *ibid.*

3. *ibid.*

Radio pioneers

Radio came to be essential to everyday living from the 1920s, when the first commercial radio stations were established throughout the world. It owes its development to the work of many pioneers who include:

Henrich Hertz. In 1886, Hertz demonstrated that rapid variations of electric current could be projected into space in the form of radio waves.

Guglielmo Marconi (pictured at right with early radio). In 1895, Marconi used these radio waves to send and receive radio signals. By 1899, he had sent a wireless signal across the English Channel. Marconi transmitted the first successful transatlantic radio telegraph message in 1901 and in 1907, he established a regular American-European wireless telegraphy service. This service only sent Morse Code across the air waves, however.



Lee de Forest. In 1907, de Forest patented the audion, a triode vacuum tube which boosted radio waves as they were received and made possible what was then called 'wireless telephony'. Wireless telephony allowed broadcast signals (for example, of voices and music) to be heard across the air.

Edwin Howard Armstrong. In the late 1930s, Armstrong constructed the first experimental FM radio broadcast station. Armstrong's enthusiasm for FM was not shared by the radio industry in America, however, and it was a number of years before the new medium became popular.⁵

Because radio has been so integral to people's everyday lives, it is logical to assume that the introduction of a radio format, which it has been argued better reflects 21st century audience needs and expectations, has the potential to have a significant impact on listening habits. And that this in turn, has the potential to enhance radio's already substantial social influence.

This paper looks briefly at what listening possibilities and other advances digital radio technology offers to audiences, considers its development and uptake in selected overseas markets and in Australia and considers its future potential.

4. Commercial Radio Australia, *All Australian Listening Report 2000*, Commercial Radio Australia website, http://www.commercialradio.com.au/index.cfm?page_id=1007, accessed on 23 January 2008.

5. For more information on these scientists see: World Book Online Reference Centre entries: Hertz, <http://www.worldbookonline.com/advanced/article?id=ar254840&st=heinrich+hertz>, Marconi, <http://www.worldbookonline.com/advanced/article?id=ar343860&st=marconi>, de forest <http://www.worldbookonline.com/advanced/article?id=ar152340&st=lee+de+forest>, and Armstrong, <http://www.worldbookonline.com/advanced/article?id=ar031000&st=edwin+armstrong>. Source for Marconi picture: Public Broadcasting Service website, <http://www.pbs.org/wgbh/aso/tryit/radio/earlyyears.html>, accessed on 5 August 2008.

Radio basics: AM and FM radio

How do AM and FM work?

Traditional radio works basically by turning sounds into electromagnetic waves and transmitting those waves across space to radio receivers (see Glossary for further explanation). To broadcast sounds as radio, a transmitting station is needed to generate the radio waves by moving electric charges rhythmically up and down an antenna. As the electric charges accelerate back and forth on the antenna, they produce changing electric and magnetic fields that recreate each other as they then travel across space in electromagnetic waves. When these waves encounter a radio receiver antenna, the electric fields push electric charges up and down this antenna, thus detecting the radio carrier wave (see Glossary and diagram below for AM radio).⁶

All waves have three parts: wavelength, amplitude and frequency. Each of these parts can be changed to carry information. In AM (amplitude modulation) radio the carrier wave is modulated or varied by changing its amplitude. In FM (frequency modulation) radio the frequency of the transmitted wave is modulated in accordance with the amplitude and pitch of the signal. AM radio generally uses a medium frequency broadcasting mode while FM uses a mode in the VHF (very high frequency) broadcasting bands.⁷ FM provides a high quality analogue signal that in comparison to AM is relatively free from static interference.⁸ The minimum geographic coverage area for AM radio is between 40 and 80 kilometres although atmospheric effects can improve AM coverage significantly, especially at night. A high-powered FM transmitter can cover an area of approximately 100 kilometres.⁹

The first AM station licensed to broadcast in Australia was 2SB, which officially went to air 13 November 1923.¹⁰ The first Australian stations broadcast under what was called the ‘sealed set’ of regulations. These entailed the licensing of a station which then sold radios that were only able to receive that station. The limitations of such a system were quickly recognised, however, and within eighteen months a two tiered system, of some stations supported by licence fees and others which generated revenues through advertising, was in place. The oldest surviving commercial radio station, 2UE in Sydney, commenced broadcasting under this scheme in January 1925.¹¹ Radio 2UE still broadcasts in the AM format.¹²

6. L. Bloomfield, Professor of Physics, University of Virginia, ‘Radio’, How things work website, <http://howthingswork.virginia.edu/radio.html>, accessed on 19 March 2008.

7. See Glossary for explanation of frequencies.

8. Commercial Radio Australia, ‘How do AM, FM and digital radio broadcasts differ?’ http://www.commercialradio.com.au/index.cfm?page_id=1011, accessed on 19 March 2008.

9. Australian Broadcasting Corporation (ABC), ‘Listening to ABC radio’, ABC website, <http://www.abc.net.au/reception/radio/listen.htm>, accessed on 26 March 2008.

10. 2SB later become 2BL, it and a ‘sister’ station 2FC, which were originally commercial stations, as were 3LO and 3AR in Melbourne, were later acquired as part of the development of the ABC (in 1932).

11. Radio Adelaide 105 FM, ‘The history of Australian radio’,

How AM radio works

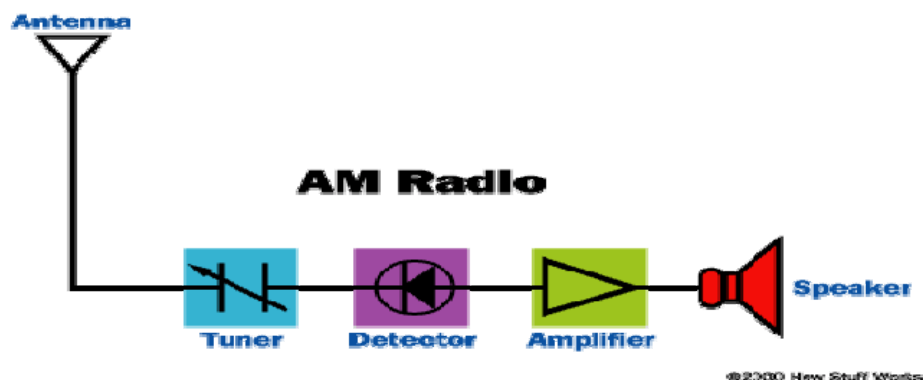

Source: How stuff works¹³

FM: superior sound quality

The only real difference between AM and FM is the technical method used to superimpose sounds. Just as Lee de Forest's invention of AM radio (see box below) was an improvement on a spark-gap transmission first used in radio telegraphy, FM broadcasting improved the quality of radio sound.

Limitations of AM radio

In the early 1930s, Edwin Armstrong developed FM radio to overcome the limitations of AM transmission. AM limitations include:

- Susceptibility to static interference from household appliances and lighting
- Limited audio quality (frequency response and dynamic range)
- Night time interference between stations because of ionospheric refraction, particularly noticeable in rural areas (called co-channel interference).¹⁴

The superiority of FM broadcasting to AM has been described in these terms:

The most striking demonstration, then as now, was to hear an FM program coming in crystal clear through a clatter of thunderstorms and electrical disturbances that turned ordinary radio reception into a nightmare of shattering discharges and steady background noise like frying eggs. In addition to its noise-suppression qualities, the wide-swinging FM wave also was

http://www.radio.adelaide.edu.au/intro/history_OZ-radio.pdf, accessed on 19 March 2008.

12. Broadcasting on the 954 kHz frequency. Like many successful AM stations, 2UE has adopted the 'talk' radio format and has featured some of Australian radio's most recognised radio names, including Gary O'Callaghan, Ward 'Pally' Austin, Bob Rodgers and John Laws.
13. See How Stuff Works website, <http://electronics.howstuffworks.com/radio8.htm>, accessed on 26 March 2008.
14. 'The dawn of FM radio', CyberCollege and InternetCampus website, 2006, <http://www.cybercollege.com/frtv/frtv020.htm>, accessed on 19 March 2008.

capable of carrying the full frequency range of sound perceptible to the human ear, giving it a depth and naturalness unknown to ordinary AM radio.¹⁵

FM radio first began in Australia in 1947. At that time, it was not welcomed by commercial broadcasters who were concerned about the cost of its introduction. Nor was it initially embraced by the public. In 1961 it was even closed temporarily to allow for the expansion of the television frequency band, but an Australian Broadcasting Control Board Inquiry in the early 1970s recommended its reintroduction. Ironically, when this occurred in 1975 the government at first prohibited commercial broadcasters from accessing the new medium, but as the popularity of FM increased so did the commercial broadcasters interest. Consequently, they lobbied government for the right to convert their stations to FM. By 1980, the government allowed a limited number of commercial FM licenses and permitted some AM to convert to FM transmission. Since the 1980s, as the popularity of FM has further increased, many AM radio stations have opted to move to FM broadcasting.¹⁶

Radio frequency spectrum

The radio frequency spectrum is part of the electromagnetic spectrum. The electromagnetic spectrum describes the full range of frequencies—from radio to gamma rays—that characterise light. Electromagnetic waves are arranged according to frequency and wavelength. Radio waves use the lowest frequency, but have the longest wavelength.

According to the Australian Communications and Media Authority (ACMA) Radio Frequency Spectrum Plan, radio frequency for AM radio for Australia is between 526.5 kHz and 1606.5 kHz (inclusive) and for FM radio between 85 and 108 MHz (inclusive).¹⁷

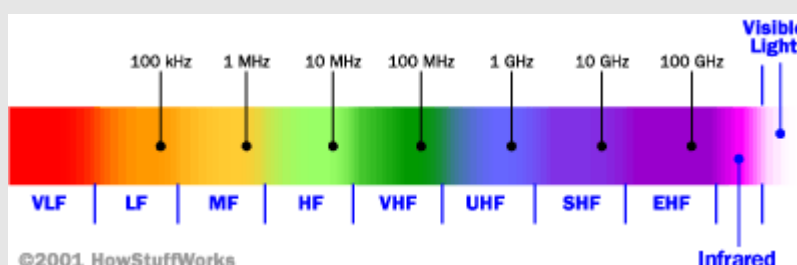

Source: How stuff works¹⁸

15. D. Raymond, 'Edwin Howard Armstrong: FM inventor', Columbia University Fathom website, Copyright 2000 by The Trustees of Columbia University in the City of New York, <http://www.fathom.com/course/10701020/session3.html>, accessed on 19 March 2008.
16. 'The history of Australian radio', op. cit.
17. See Australian Communications and Media Authority (ACMA), (Draft) *Australian Radio Frequency Spectrum Plan 2009*, http://www.acma.gov.au/webwr/assets/main/lib310708/spectrum_plan-public_consultation.pdf, accessed on 28 August 2008.
18. M. Brain, 'How the radio spectrum works', How stuff works website, <http://www.howstuffworks.com/radio-spectrum.htm>, accessed on 26 March 2008.

Digital radio

Definition

Essentially, digital radio technologies turn sound into digital signals which are then compressed, transmitted and recoded back into sound by digital radio receivers.¹⁹

Benefits of digital radio

Some have labelled the improvements over AM and FM radio broadcasting that digital radio can deliver as ‘electrifying’.²⁰ While this assessment is overly enthusiastic according to other assessments, there appears to be general agreement that digital radio has the potential generally to provide an improved listening experience for audiences.

The benefits of digital radio are often promoted as:

- Better sound and reception. Digital radio gives ‘sound quality that's on par with listening to a [compact disc]’ and interference caused by signals ‘bouncing’ off structures or geographical features is minimal.²¹
- More listening choice. As more stations can be broadcast within the same amount of spectrum (see explanation of spectrum later in this paper) on digital radio, it can deliver a greater number of specialist program formats.
- Easy tuning. Listeners can tune into stations by name, rather than frequency.
- Rewind and record features. Digital radios are able to pause, rewind or store data for later listening.²²

19. ACMA, ‘Digital radio’, http://www.acma.gov.au/WEB/STANDARD/pc=PC_90054, accessed on 23 January 2008.

20. A. Iqbal, ‘Digital radio benefits’, 25 February 2001, Suite101.com, http://www.suite101.com/article.cfm/consumer_electronics/58619, accessed on 22 January 2008.

21. R. Ramsay, ‘Digital radio. All you need to know’, CNet.com.au, 17 October 2005, <http://www.cnet.com.au/hometheatre/audio/0,239025973,240053702,00.htm>, accessed on 23 January 2008. Note, however, that the quality of digital radio depends on transmission bitrates. Higher bitrates produce higher audio quality. If too many digital stations broadcast from a multiplex the bitrates available for broadcasters need to be reduced. The digitalradiotech.com.au website (accessed on 27 November 2008) in a criticism of DAB radio in the United Kingdom makes this point. It notes that the majority of United Kingdom stations use the 128 kbps bitrate so they can ‘cram’ stations into multiplexes and that this results in ‘audio quality being sacrificed’. A 1996 report from ACMA makes the point that a bit rate of 224–256 is required to produce CD quality audio, while a bit rate of 128–192 is FM comparable. ABA, DRB Taskforce, Spectrum Requirements Working Party, *DRB for Australia: Technical possibilities and spectrum allocations*, Australian Broadcasting Authority, Canberra, 1996, quoted in J. Given, *Turning off the Television, Broadcasting's uncertain future*, University of New South Wales Press, 2003, p.144.

- Accompanying data display. Digital radio receivers are fitted with small screens for text information about the programs being aired. It has been envisaged that as digital radio develops, receivers will also be able to present graphics, pictures and web pages.²³

An added advantage over analogue radio is that digital radio is able to use single frequency network technology. In analogue technology in order for broadcasts to be heard over large areas, stations use several frequencies, whereas digital radio allows the broadcast of stations through a number of transmitters on the same frequency, across a region or nationally. This is not possible with analogue transmissions ‘as in areas that receive signals from different transmitters broadcasting on the same frequency there is considerable mutual interference’.²⁴

However, while it can be argued that this feature makes single frequency networks not only more convenient for listeners, but also more spectrum efficient, it should be noted that these networks also have their limitations. Single frequency networks work well only if the exact content is transmitted from each transmitter involved in the network, and if each transmission is accurately timed and coordinated (see Glossary for explanation of terms). Similarly, single frequency networks do not allow for local programs to be transmitted from a transmitter connected to the network.²⁵ Consequently, single frequency networks may be problematic in the Australian context given that current media regulation requires a specified quota of local content to be broadcast on regional radio.²⁶

Development of digital radio

Digital radio systems can be differentiated by their technical characteristics and whether they can be classified as open or proprietary, that is, by the extent to which they can be used freely by broadcasters.²⁷ Open standards can be used by all broadcasters provided they meet licensing conditions, whereas proprietary standards can only be used with the agreement of their owners. Digital radio innovation has usually been the product of a number of

-
22. Note: these features are not available on all digital radios.
 23. ABC Radio, digital radio page, <http://www.abc.net.au/radio/digital/>, accessed on 23 January 2008.
 24. See also explanation on the digital Radio Mondiale website, <http://www.drmmradio.co.uk/html/sfn.html>, accessed on 28 August 2008.
 25. See also technical explanation of single frequency networks at ENENSYS Technologies, Technical overview of single frequency network, www.enensys.com, accessed on 7 October 2008.
 26. H. Coonan, Minister for Communications, Information Technology and the Arts, *Safeguarding local radio content in regional Australia*, media release, Parliament House, Canberra, 13 September 2007, http://www.minister.dcita.gov.au/coonan/media/media_releases/safeguarding_local_radio_content_in_regional_australia, accessed on 7 October 2008.
 27. Ofcom, The International Communications Market 2006, <http://www.ofcom.org.uk/research/cm/icmr06/radio.pdf>, accessed 21 January 2008.

competitors developing proprietary standards, which have then been transformed into an open standard that combines the best features of the earlier standards.²⁸

Digital Audio Broadcasting: DAB

Digital Audio Broadcasting (DAB), an open digital standard, was developed after digital sound systems first produced for satellite delivery in Germany in the early 1980s experienced problems, such as those resulting from their use of minimal data compression. In the mid 1980s, a technical consortium from France, Germany, the Netherlands and the United Kingdom received funding from Eureka, a pan-European initiative, to attempt to overcome these problems by producing a unique digital audio broadcasting system.

This 147th project funded by Eureka (Eureka 147) produced Digital Audio Broadcasting (DAB) radio. DAB works by combining two digital technologies.²⁹ The first of these, MPEG layer 2 or MP 2 compresses digital information to be broadcast.³⁰ It does this by discarding sounds that will not be perceived by listeners and packaging together information that remains for transmission. The second technology, Coded Orthogonal Frequency Division Multiplex (COFDM), ensures that signals are received, even in environments normally prone to interference.

DAB radio uses a multiplex to combine a number of programs into a single data stream for transmission. A DAB multiplex is made up of ‘bits’ which are used for carrying audio, data and an error protection system against transmission errors. It is possible to allocate a different number of bits on a multiplex to different services at different times and stations. DAB radio can deliver five compact disc quality stereo radio services (or more, if the services are of lesser audio quality) over a medium bandwidth of approximately 1.5 MHz (see Glossary for further explanation).

The first DAB prototype was demonstrated in 1988 and a Eureka 147 standard for digital radio was defined by 1993. An international forum was formed in 1995 to encourage world-wide cooperation and coordination of the introduction of Eureka 147 onto the consumer market. The first DAB radio services commenced transmitting in the United Kingdom and Sweden in the same year.

In November 2006, the World DMB (Digital Multimedia Broadcasting) Forum adopted an upgraded DAB digital radio standard known as DAB+.³¹ This technology has been promoted

28. Nortel Networks, Submission to Department of Communications, Information Technology and the Arts Convergence Review, January 2000, http://archive.dbcde.gov.au/_data/assets/pdf_file/0018/21744/nortel.pdf, accessed on 27 May 2008.

29. Eureka is a European intergovernmental initiative to encourage market-oriented, industrial research and development.

30. MPEG stands for Moving Pictures Expert Group, a working group of the International Organization for Standardization. There is some suggestion that this technology could also be labelled MUSICAM or Masking Pattern Adapted Universal Sub-Band Integrated Coding and Multiplexing, but generally the former label is applied.

31. World DMB was previously known as the WorldDAB Forum.

as more spectrum efficient than its predecessor, which means it has increased capacity for more stations and lower transmission costs.³²

Diagram of Eureka 147 DAB digital radio

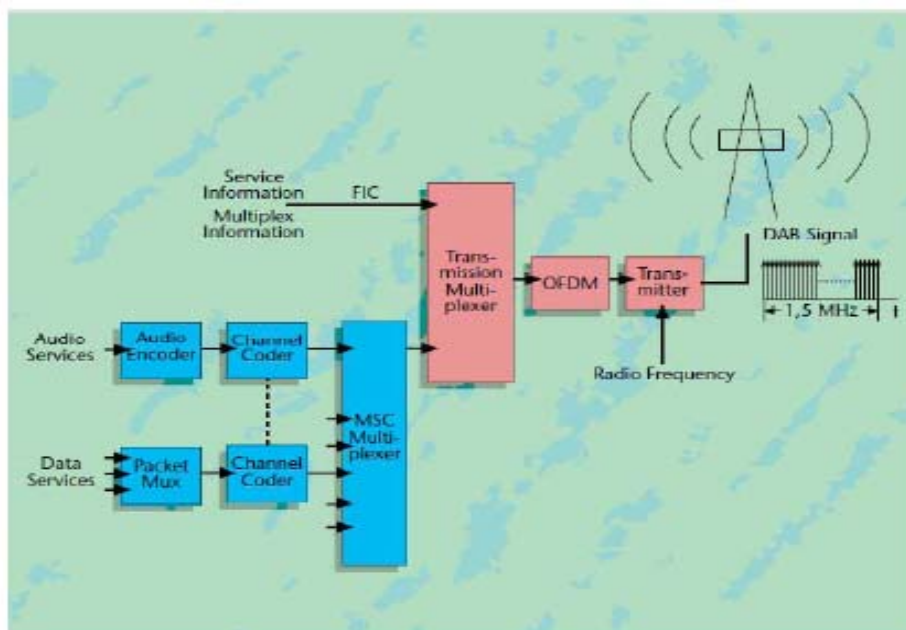

Conceptual diagram of digital radio signal generation
(picture credit: Eureka 147 Project Office/The World DAB Forum)

Source: Digital Radio Australia³³

Country development

Arguably, Britain is DAB's greatest success story. Ten years after the introduction of digital radio there were 172 commercial stations broadcasting to the British public on DAB. However, it should be noted that two thirds of these were simulcasts of existing locally-based analogue stations. In the same year, the British Broadcasting Commission (BBC) United Kingdom-wide multiplex carried simulcasts of its five analogue network stations, five digital only services that transmitted to the whole of the United Kingdom and the BBC World Service.³⁴

DAB radio has been less successful in Europe. This is despite the Europeans having a similar commitment to the idea of public broadcasters as the driving force behind broadcasting innovation as exists in Britain. From 1995 onwards, the national broadcaster in Sweden for example, was the only operator of DAB radio because it was considered by government that

32. Ofcom, *International communications market*, op. cit., Chapter 4, 'Radio'.

33. Diagram at Digital Radio Australia, http://203.63.5.202/files/uploaded/file/Digital_Radio/digital_typical_multiplex.pdf, accessed on 21 January 2008.

34. Mori, op. cit.

economic conditions were ‘not sufficiently favourable’ for commercial operators.³⁵ Originally also, a national multiplex provided 85 per cent of the Swedish population with DAB digital radio access, but after government funding was reduced for services in 2002, this contracted to 35 per cent. In 2005, Sweden announced that it would suspend extension of its DAB network.

In justifying this decision the Swedish Government indicated that it was concerned about the cost of running AM and DAB networks in parallel and the consequences which would arise if it shut down FM radio—25 to 30 million radio receivers that would no longer work. A three year study has since been commissioned to examine the possibilities for future digital radio policy in Sweden.³⁶

The Finland experience has been similarly disappointing. Finland began DAB broadcasting over its national broadcaster in 1998 and later expanded services to reach 40 per cent of the population through a national and regional multiplex. But the cost of establishing commercial networks and the lack of affordable digital radio receivers prevented further expansion and by the end of 2005, Finnish DAB services were closed. DAB transmissions continue over digital television and the Internet and the Finnish Government has noted that it may reconsider the DAB technology if a pan-European distribution standard were to be adopted. But this quasi commitment to DAB appears a little hollow, as at the same time the Finns are exploring the potential of alternative digital technologies such as DVB-H (Digital Video Broadcasting–Handheld) and DMB (Digital Multimedia Broadcast).³⁷

The positive for digital radio from this outcome is that the concept of digital radio itself has not been abandoned by either the Finns or the Swedes and there are reports that other European countries, such as the Netherlands, are also exploring the merits of alternative digital radio technologies.

It has been suggested that a major impediment to the implementation of digital radio in Northern Europe has been the model of maintaining a public service monopoly of radio broadcasting in Scandinavian countries. This is in contrast with the British decision to

35. The Panel on Information Technology and Broadcasting, Legislative Council Secretariat, Research and Library Services Division, *Digital audio broadcasting in Finland and Sweden*, Information Note, IN32/05–06, <http://www.legco.gov.hk/yr05-06/english/sec/library/0506in32e.pdf>, accessed on 26 May 2008.

36. Digital audio broadcasting in Finland and Sweden, op. cit.

37. *ibid.* Note: DMB (Digital Multimedia Broadcasting) There are two DMB standards: T–DMB (Terrestrial) and S–DMB (the satellite equivalent). DMB facilitates the carriage of audio, pictures, video and data and was developed in South Korea in 2005, where there are now 12 T–DMB and 19 S–DMB audio channels, alongside television and data channels. S–DMB is used by satellite radio providers XM and Sirius in North America and by MobaHo in Japan. France, Germany and Italy are also looking at developing terrestrial DMB services. DVB–H (Digital Video Broadcasting–Handheld) is a standard developed to provide broadcast services to portable handheld devices. DVB–H technology is based on the DVB–T (Digital Video Broadcasting–Terrestrial) system that is used for digital terrestrial television, with additional features to meet the specific requirements of handheld, battery-powered receivers. The WorldDMB Forum makes the point that DMB is part of the same group of standards as DAB and DAB+, ‘About WorldDMB’, http://www.worlddab.org/about_worldddb, accessed on 6 August 2008.

encourage commercial radio to invest in digital.³⁸ While this is most likely not the only explanation for this situation, there are positive implications for the launch of Australian digital radio which will from the onset provide a mix of commercial and public services.

Outside Europe, trials of DAB radio are being undertaken in a number of countries, including India, Mexico and South Africa. DAB has been adopted in Singapore and South Korea and in some provinces of China, where over 27 million people can receive DAB transmissions.³⁹ In China in May 2006, European DAB standard became the digital broadcasting industry standard. Digital multimedia broadcasting (DMB) and data information services based on DAB are being gradually developed, and Beijing Radio has broadcast digital programs since November 2006.⁴⁰ The Singapore Broadcasting Authority, like the BBC, has also been at the forefront of DAB implementation in that country.⁴¹

Differences between DAB and DAB+

To enable a multiplex to transmit a number of stations, audio compression is used to reduce the data rate of each station being transmitted. In taking advantage of the fact that when the human ear detects sound on one frequency it is less sensitive to quieter sounds on nearby frequencies, an audio compression coder calculates a noise floor below which sound cannot be perceived by listeners and discards those sounds.

The audio coding standard used for DAB is MP2. The code used for DAB+ HE-AAC v2 (also known as MP4 or AAC+) however, is more compression efficient. It allows for the equivalent or better subjective audio quality to be broadcast at lower bit rates than DAB. It has been argued that this, in turn, is more spectrum efficient as more stations can be broadcast on a multiplex, less transmission cost is incurred per station and a wider choice of stations becomes available.

The geographical coverage area of radio services using HE-AAC v2 is also slightly greater than for those using MP2.⁴²

-
38. S. Lax, M. Ala-Fossi, P. Jauert and H. Shaw, 'DAB: the future of radio? The development of digital radio in four European countries', *Media, culture and society*, vol. 30 (2), 2008, p.156.
 39. Ofcom, *International radio market*, op.cit. Note: Singaporeans also have access to DAB+ through a subscription service introduced in June 2008, WorldDMB website, 'Country information. Singapore', http://www.worlddab.org/country_information/singapore, accessed on 6 August 2006.
 40. Report Buyer, Summary of China digital audio broadcasting market report 2007, 28 February 2008, <http://www.prlog.org/10049806-china-digital-audio-broadcasting-market-report-2007-new-business-publication-from-report-buyer.html>, accessed on 26 May 2008.
 41. B. O'Neill, 'Digital audio broadcasting in Canada: technology and policy in the transition to digital radio', *Canadian Journal of Communication*, vol. 32, 2007, p. 80.
 42. For more information see Frequency Finder UK website at http://mysite.wanadoo-members.co.uk/freq_find/DAB_works.html, accessed on 26 July 2008.

Development of other digital radio systems

Since the launch of DAB technology, other digital radio services have been developed and introduced. These include satellite based digital services, which were introduced in the late 1990s, HD (Hybrid Digital) Radio, a terrestrial based standard approved in 2002, Digital Radio Mondiale (DRM), a standard for AM digital radio announced in 2003 and (ISDB-T), a digital terrestrial standard for television and radio available in Japan also since 2003.

Digital Radio Mondiale: DRM

Like the DAB system, DRM was initiated by a consortium of international broadcasters and equipment manufacturers and began as a Eureka project—Number 1559. The DRM consortium at present has a membership of over 80 organisations including national broadcasters, research institutes, regulatory agencies and regional broadcasting unions.

DRM is an open digital standard. It is a narrowband technology that, like DAB, uses COFDM; like DAB+, it uses HE AACv2. DRM has often been referred to as digital AM because DRM stations use spectrum currently allocated to AM transmissions and they can be transmitted on the same frequency as standard analogue radio. DRM is not subject to the same fading and distortion as AM however, and DRM transmitters can share a single frequency without interference. DRM can also use frequencies not suitable for AM in a given area. DRM has added advantage—wide area signal propagation and as such, it is often the only alternative to provide service to large geographical areas.

In April 2001, the DRM system was endorsed by the International Telecommunication Union as a standard for digital radio in the bands below 30 MHz (that is, the short, medium and long wave bands) and its technical specification was adopted as a standard. The first regular DRM transmissions were initiated by Deutsche Welle, Radio Netherlands, the BBC World Service, Voice of America, Swedish Radio International and Christian Vision in June 2003.⁴³

DRM and WorldDAB announced in August 2003 that they would collaborate in the development of their digital radio systems with the intention of producing a hybrid DAB–DRM receiver.⁴⁴ A prototype of this receiver was demonstrated at the 2004 International Broadcasting Conference in Amsterdam.

DRM+, which it is intended will be able to operate in all broadcasting bands below 120 MHz, is also in the design phase.⁴⁵

43. Deutsche Welle, Radio Netherlands, the BBC World Service, Voice of America and Swedish Radio International are government-funded, editorially independent, international broadcasters. Christian Vision is a private broadcaster which broadcasts to Africa, Asia, the Americas and Australia.

44. WorldDAB Forum and Digital Radio Mondiale, 'WorldDAB Forum and Digital Radio Mondiale agree to cooperate over future of digital radio', press release, 30 August 2003.

45. See 'Introduction to DRM', Frequency finder UK and Ireland website, http://mysite.wanadoo-members.co.uk/freq_find/about_DRM.html or DRM consortium website <http://www.drm.org/meta/consortium/> for more detail. Sites accessed on 26 March 2008.

Hybrid Digital (HD) or In-Band On-Channel (IBOC)

According to one commentator, while in the 1980s the United States Association of Broadcasters was impressed by DAB technology, the broadcasters were unable to secure the use of the spectrum to implement the technology as it was allocated for use by the American military. As a result, the Americans decided to develop their own digital protocol.⁴⁶

In 1991, broadcasters CBS, Gannett, and Westinghouse combined to work on the alternative digital standard to DAB which they believed could be produced for AM and FM radio. By 2000, a company formed by the broadcasters and a group of technology partners, the iBiquity Digital Corporation, delivered what was called the In-Band On-Channel (IBOC) method of broadcasting.

The IBOC system provided the principle which underpins America's Hybrid Digital (HD) radio technology. HD radio is a proprietary standard that transmits digital signals within unused portions of the same channel as analogue AM and FM signals—hence, the label in-band on-channel. HD radios are designed to pick up both AM and FM signals, tuning in first to the analogue signal and then to its digital counterpart—hence, a hybrid digital system. This practice has a downside as interference can be picked up from neighbouring channels. Importantly however, the upside is that it avoids the need to allocate extra, precious spectrum to this technology.

In October 2002, the American communications regulator, the Federal Communications Commission, selected IBOC as the sole digital standard for radio in the United States.⁴⁷

How FM HD Radio works

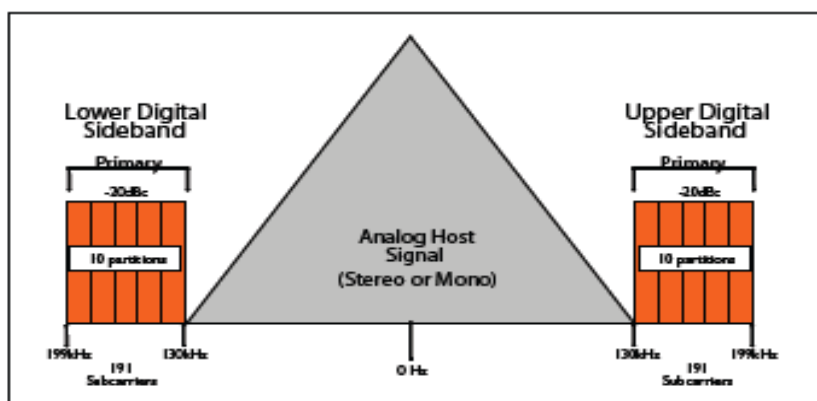

FM HD Radio—Hybrid Mode

Source: Broadcast Electronics⁴⁸

46. J. Anderson, 'Digital radio in the United States. Privatisation of the public airways?' *Southern Review*, Volume 39, Number 2, 2006, p.6.

47. Written and audio statements from the FCC Commissioners regarding IBOC are at <http://www.diymedia.net/audio/mp3fcciboc.htm>, accessed on 25 July 2008.

Other terrestrial digital standards

A number of other terrestrial broadcasting standards exist. These include:

Digital Video Broadcasting–Terrestrial (DVB–T)

Digital Video Broadcasting (DVB), while primarily designed for television broadcasting, may also be used for other applications such as broadcasting audio and data services (see Glossary). The Digital Video Broadcasting–Terrestrial (DVB–T) system has been deployed in many countries, within existing broadcasting service band allocations, including VHF Band III and UHF Bands IV and V. As with DAB, the use of DVB–T for digital radio requires programs to be multiplexed together at a central point prior to their transmission.

While the DVB–T system is used in Australia primarily to broadcast free-to-air digital television, it is also used to distribute some Australian Broadcasting Corporation (ABC) and Special Broadcasting Service (SBS) radio services. The ABC uses the system to broadcast its Internet radio service, Dig, while the SBS uses it to simulcast its two radio channels.

Satellite digital radio

Geostationary satellites may also be used to deliver digital radio services.⁴⁹ While satellite radio can cover a much wider geographical area than terrestrial-based radio, antennae for satellite radio must have a clear view to the satellite to operate efficiently and this view can be obscured by buildings or geographical features. To overcome this problem, repeaters are used to relay satellite signals.

In areas with a relatively high population density, it is thought not only to be easier, but also to be less expensive to reach listeners with terrestrial broadcasts. Satellite radio has many benefits for sparsely populated rural areas, however.

Satellite radio was first launched in 1999 by WorldSpace whose AfriStar satellite provided services to Africa, the Middle East and parts of Europe. In 2000, an AsiaStar satellite with an operational centre in Melbourne began services to Asia. In the United States, satellite digital radio commenced in 2002.

Terrestrial Integrated Services Digital Broadcasting (ISDB–T)

Terrestrial Integrated Services Digital Broadcasting (ISDB–T) is a wideband system similar to the DVB–T system (see Glossary). Each ISDB–T service, however, can be segmented into separately receivable sub-bands which can be used to provide sound broadcasting services and this is known as ISDB–TSB.

48. Broadcast Electronics, 'The BE guide to HD radio. All the basics and more', brochure at Broadcast Electronics website, <http://www.hdradio.ch/downloads/behdradioprimer.pdf>, accessed on 25 July 2008.

49. Digital Radio Study Group (DRSG), Report to the Minister for Communications, Information Technology and the Arts, March 2004, http://archive.dbcde.gov.au/2008/03/the_introduction_of_digital_radioissues_paper_submission_s_closed/digital_radio_study_group, accessed 27 March 2008.

ISDB-T is the system also used in Japan for television. ISDB-TSB began experimental transmissions in a number of Japanese cities in October 2003.

Digital radio for Australia

Policy development and implementation

Step 1: investigation

In the early 1990s, the Labor Government's Minister for Transport and Communications, Kim Beazley, declared that digital radio would not be allowed to suffer the fate of FM—waiting until the technology was 30 years old before its introduction.⁵⁰ As a consequence, in 1994, the first of a series of taskforces and advisory bodies was set up to investigate the viability of digital radio for Australia. By 1997, a Digital Radio Advisory Committee (DRAC) recommended the adoption of digital radio which used the Eureka DAB technology. Although this committee saw DAB as the most appropriate for Australia's needs at the time, it 'hedged its bets' in noting there was merit in also monitoring development of the alternative digital radio systems being considered in places like the United States.⁵¹

The DRAC report recommendation was that a transition to digital radio should consist of a development phase, wherein frequencies would be allocated and licences offered to existing broadcasters and narrowcasters. These licences would allow the broadcasters freedom to simulcast on digital and analogue frequencies and to experiment with technologies and services. This phase would then lead into full transition, under which the market would be opened up for new entrants.⁵²

In March 1998, the Minister for Communications, Richard Alston, announced that digital radio would be available to Australians by 2001.⁵³ At that time broadcasters would share a number of multiplexes, each of which would carry five CD-quality radio services.⁵⁴ During the next five years, however, delays to trials, uncertainty about the various digital radio technologies and an apparent relaxation of the government's commitment meant that by 2003, digital radio was not a reality for Australian audiences. At this time, the government announced yet another study to be undertaken by the Digital Radio Study Group (DRSG).

50. M. Day, 'Radio flounders in digital doldrums', *Australian*, 17 October 2002, refers to Beazley's speech to the annual conference of the Federation of Australian Broadcasters 1990–1991 (now known as Commercial Radio Australia) in which Beazley made this statement.

51. Digital Radio Advisory Committee (DRAC), *Digital radio broadcasting in Australia*, August 1997, http://archive.dcita.gov.au/1997/august/digital_radio_broadcasting_in_australia_report_1997, accessed on 22 January 2008.

52. *ibid.*

53. R. Alston, (Minister for Communications, Information Technology and the Arts), *Digital broadcasting a step closer*, media release, Parliament House, Canberra, March 1998.

54. Given, *op. cit.*, p.150.

Digital radio trials

From mid 1996 to early 1997, an initial series of digital radio trials took place in Australia. Some were conducted by Telstra in Melbourne and involved three ABC stations, one SBS station and one community station as well as a number of commercial stations.⁵⁵ The Department of Broadband, Communications and the Digital Economy, in conjunction with Optus and the then National Transmission Agency, also conducted trials.⁵⁶

Further digital radio trials were proposed to start early in 2002 after ACMA allocated spectrum between that used for transmission by Channels Nine and Ten. A number of problems delayed commencement of the trials until 2003. Initially, television stations expressed concern that digital radio transmissions would interfere with their television signals. The trials were to prove these fears incorrect, however.⁵⁷ Long delays were also experienced in gaining local council permission to extend Channel Nine's radio antenna by three metres to accommodate the trials.

Additionally, the commercial radio industry was outraged when the government decided to allow the broadcast tower operator Broadcast Australia to conduct the trials in Melbourne.⁵⁸ The broadcasters considered that the trials should have been restricted to existing operators, in recognition of their investment in the industry.⁵⁹ The broadcasters argued also that the government was giving an implicit right to spectrum to Broadcast Australia and that this would lead to a valuable public resource 'being held by an organisation with no public interest or community service obligations and to radio stations being charged exorbitant access fees'.⁶⁰

The government dismissed the industry's concerns arguing that gaining the right to conduct trials carried no presumption of broadcasting rights, and from 2003, the trials of DAB (and DRM) standards were begun in Sydney and Melbourne.⁶¹ These trials also involved commercial radio, the public broadcasters (ABC and SBS) and community stations.

55. M. James, *A digital television and radio future?* Research Note No 5, Australian Parliamentary Library, Canberra, 1996–97.

56. Current title; this department was known as the Department of Communications and the Arts at that time.

57. J. Schultze, 'TV networks fizz as digital radio buzzes waves', *Australian*, 18 December 2001.

58. Broadcast Australia owned 580 transmission towers. It was owned by Macquarie Communications Infrastructure Group.

59. C. Marriner, 'Radio operators not amused', *Sydney Morning Herald*, 29 October 2003, p. 26.

60. J. Warner, chief executive of Commercial Radio Australia quoted in N. Shoebridge, 'Broadcasters turn on Williams', *Australian Financial Review*, 17 November 2003, p. 57.

61. See trial sites for Melbourne at Broadcast Australia website, <http://www.broadcaustralia.com.au/innovative-broadcasting/digital-radio-trials.aspx> and for Sydney at the Digital Radio Australia website http://www.digitalradioaustralia.com.au/index.cfm?page_id=1022, accessed on 25 January 2008. The Sydney trials were undertaken by a consortium of broadcasters—Austereo Network, Australian Radio Network, DMG Radio Australia, Macquarie Radio Network, Southern Cross Broadcasting, 2KY, 2SM, the ABC and SBS.

While initially intended for a period of 18 months, ACMA later extended the trials.

In 2006, Broadcast Australia, in conjunction with SBS, also undertook a series of DRM field tests over a seven month period from a site in Canberra. This trial explored a range of services, obtained field performance measurements and evaluated a range of transmission equipment and receivers. Phase two of this trial was completed in 2007.⁶²

Step 2: discussion and more discussion

In late 2004, the DRSG released its digital radio discussion paper. This paper confirmed an obvious fact that commentators had already noted—many issues relating to the introduction of digital radio remained unresolved.⁶³ One of these—the question of whether DAB radio was actually the appropriate digital radio technology for Australia—seemed to be a fundamental one.⁶⁴ A consequential question raised as a result of the study was whether Australia should ‘wait and see’ what technological developments occurred before actually committing resources to DAB.

Prior to the 2004 election, the Howard Government was extensively criticised by commercial radio operators for delaying its decisions on digital radio. The media speculated at the time that there was ‘more than a whiff of pre election politics at play’ in the government’s actions.⁶⁵ During the 2004 election campaign, however, the government responded to the industry’s lobbying with a commitment to work with it in developing digital radio policy. It announced a five-year moratorium on the issue of new commercial digital radio licences, arguing that this timeframe was needed to resolve technology and spectrum issues and to determine the timetable for the rollout of digital services.⁶⁶

By April 2005, the commercial radio industry responded to the 2004 discussion paper released by DRSG, arguing that digital was the future of radio; a natural evolution similar to the replacement of analogue television with digital and analogue mobile phones with digital phones.⁶⁷

62. ABU Digital Radio Forum, An update on the latest digital radio developments worldwide for July 2007, 1 July 2007, <http://www.abu.org.my/public/documents/ABU-DigitalRadio-July2007.pdf>, accessed on 13 May 2008 and Broadcast Australia website, op. cit.

63. Media commentator and Senior Research Fellow at Swinburne University’s Institute of Social Research, Jock Given, for one, argued that while DAB radio was an appropriate technology choice in 1998, development in other technologies since that time had raised the question of whether it was the right choice five years later. Given is quoted in S. Mitchell, ‘Radio’s digital daze’, *Australian*, 12 November 2002.

64. DRSG, *Report*, op. cit.

65. F. Benchley, ‘Radio anger goes off the dial’, *Australian Financial Review*, 15 July 2004, p. 9.

66. The Howard Government, Election 2004 policy, *21st century broadcasting*, <http://parlinfoweb.parl.net/parlinfo/Repository1/Library/partypol/NP2E60.pdf>, accessed on 30 January 2008.

67. Commercial Radio Australia, *Response to Digital Radio Study Group report and issues paper*, Commercial Radio Limited, April 2005, p. 3.

The DRSG discussion paper had been cautious in its recommendations about how the implementation of digital radio could be achieved, citing the possible options of full conversion, a market based approach or a managed approach.⁶⁸ While it acknowledged that full conversion had been chosen as the appropriate strategy for the transition to digital television, the DRSG was not convinced that a similar strategy was suitable for digital radio. Its reticence was prompted by the larger number of radio operators, wider variety of service categories and by the fact that spectrum efficiency gains were likely not to be substantial should analogue radio services be switched off. Nor was it clear what alternative uses could be made of the spectrum gained if this were to occur. The DRSG concluded that while a conversion only approach would provide certainty for incumbent broadcasters, a more competitive approach may be more beneficial in providing incentives for broadcasters to invest in new and innovative infrastructure and services.⁶⁹

Commercial broadcasters, however, supported a ‘full conversion’ option arguing that they were ‘ready and willing to drive the introduction of digital radio to audiences throughout Australia’.⁷⁰ The broadcasters also supported DAB as the ideal choice for digital radio, as in their view, it was not only the most mature of the digital technologies, but also ‘the most powerful’.⁷¹ While they acknowledged DRM as a possible supplementary option to DAB for sparsely populated areas, they rejected that technology as a solution for metropolitan and more populated areas for a number of reasons which included the noise factor associated with broadcasts on AM. Similarly, IBOC was seen as inappropriate for Australia because of its proprietary nature, the costs associated with producing receivers and its lack of flexibility—it was classified as simply a simulcast of existing analogue services

68. A market based approach was one under which broadcasters could decide which services they delivered subject to minimal regulatory requirements, such as spectrum allocation. The advantages of this approach were that it provided the maximum opportunity for new broadcasters to enter the market and for the development of innovative new services to emerge. It did not however, provide certainty for existing broadcasters and was likely to be problematic for non-commercial broadcasters who would be unable to compete in an open market to acquire spectrum for example.

A managed approach would combine elements of the full and market approaches. Priority of access to digital capacity could be given to those incumbent broadcasters interested in commencing digital broadcasting, but at the same time provision could be made for new broadcasters and innovative service providers to enter the market. Similarly, price mechanisms could be in place to determine access to spectrum for commercial broadcasters and at the same time spectrum could be made available for non-commercial services.

69. DRSG, *op. cit.*

70. Commercial radio response, 2005, p. 3.

71. *ibid.*, p. 7.

The case of World Audio

Commercial radio broadcasters are licensed to provide services and to gain access to the means of carriage of the service, the radio frequency spectrum. Commercial broadcasters operate in the broadcasting services bands of the spectrum which cover AM and FM frequencies. Because this spectrum is a scarce resource, commercial broadcasting licences are in limited supply.

Operators are able to apply for broadcasting licences outside the broadcasting services bands under section 40 of the *Broadcasting Services Act 1992*. Section 40 licensees are only licensed to provide services; they need to make their own arrangements regarding the carriage of those services.⁷²

One important concession for the transition to digital radio made to the radio industry by the Howard Government was the introduction of a moratorium for incumbent licensed commercial broadcasters for a six year period.

In a submission to the government in May 2005, however, World Audio, which held an Australia wide section 40 licence to broadcast its commercial services on low powered frequencies, claimed it was an incumbent radio broadcaster. To support its application, World Audio noted that its broadcasts were carried on the Foxtel and Austar pay television and it streamed programs through the Internet. It was also participating in the Melbourne digital radio trials and was undertaking satellite radio trials from Darwin.⁷³

World Audio had in fact established the country's only national commercial radio network, Radio 2. The argument in favour of recognising World Audio as an incumbent broadcaster was that its involvement in the transition to digital would encourage other commercial operators not to delay in providing digital services. Similarly, it would ensure more diversity in services and encourage public take up of digital radio and in particular, it would ensure that services were delivered to regional and rural areas more quickly.⁷⁴

The commercial broadcasters argued in turn that the government had specifically referred to existing commercial and public broadcasters in its digital radio commitment and that World Audio did not qualify for this classification. This was because it was operating outside the broadcasting services band. No doubt this argument stemmed from the possible business advantage World Audio would acquire over the commercial broadcasters because it was not required to pay significant spectrum licensing fees. Commercial operators such as DMG, for example, paid \$155 million for its Nova FM licence, whereas World Audio had reportedly only paid \$25 million for its entire operation.⁷⁵

It was noted at the time by one observer that diversity and choice 'seemed to have played second fiddle to the need to keep the kings and queens of commercial radio talkback on side'.⁷⁶

Failure to access a digital licence appears to have had a significant effect on World Audio, which by March 2006 had gone into voluntary administration.

72. See ACMA website for explanation of conditions on commercial free to air licences http://www.acma.gov.au/WEB/STANDARD/pc=PC_90185 and non broadcasting service band licences http://www.acma.gov.au/WEB/STANDARD/pc=PC_90188 accessed on 28 July 2008.

73. M. Day, 'Interloper lobbies for new licence', Media Spy Report, 5 May 2005, <http://www.mediaspy.org/forum/index.php?showtopic=3549>, accessed on 28 July 2008.

74. B. Haslem, 'World Audio out in the cold', Jackson Wells Morris website, <http://jacksonwells.com.au/World-Audio-Out-In-The-Cold.ashx>, accessed on 28 July 2008.

75. DMG licence cost quoted by M. Barton, 'Digital rocks, but satellite promises new sound effects', *smh.doc.au*, 18 January 2005, <http://www.smh.com.au/news/Technology/Digital-radio-around-the-corner/2005/01/17/1105810845557.html>, accessed on July 29 2008 and Haslem, op. cit., for reference to the establishment cost for World Audio.

76. Haslem, op. cit.

The issue of whether full conversion to digital radio is the best policy was revisited later in 2005 when concerns were raised that until analogue services were switched off, digital radio would not be able to equal the coverage achieved by existing analogue radio services, especially in regional areas. It was suggested at that time that a dual standard DRM–Eureka 147 may be in the development stage and that in the interim, the solution to this problem could be adoption of the DRM, rather than the DAB standard.⁷⁷

In May 2005, ACMA undertook a study of spectrum availability for digital radio, yet another issue which had been raised in the DRSG discussion paper.⁷⁸ This review was in part a response to a request from Commercial Radio Australia that the government reserve spectrum for digital radio in the VHF bands. ACMA concluded that ‘shortage of suitable spectrum [was] likely to be a significant constraint on the development of digital radio in Australia’.⁷⁹ As a result, it contemplated the possibility of restricting access to broadcasting services band spectrum that may be needed for digital radio.⁸⁰ After considering submissions on this matter ACMA decided in November 2005 that it would evaluate future applications for spectrum individually, taking into consideration DAB digital radio requirements in VHF Band III and the possibility of future requirements for DRM.⁸¹

Spectrum and digital radio

The various digital radio technologies are designed to operate in particular parts of the radio spectrum. In most parts of Europe, VHF Band III (174–230 MHz) and/or L–Band (1452–492 MHz) are used for terrestrial digital radio services.

In Australia, many parts of the VHF Band III have been used to broadcast terrestrial television services. This has left little spectrum for digital radio. Digital radio trials have found however, that it is possible to locate DAB digital radio multiplexes on Channel 9A (202–209 MHz) between two analogue television services without causing interference to either analogue or digital television services.⁸²

77. ABA 2005, op. cit.

78. ACMA was formed on 1 July 2005 after the merger of its predecessor, the Australian Broadcasting Authority (ABA) and the Australian Communications Authority (ACA). The study was initiated by ABA but submissions were assessed by the new authority.

79. Australian Broadcasting Authority (ABA), *Spectrum for digital radio*, Canberra, May 2005, http://pandora.nla.gov.au/pan/53006/20051006-0000/www.aba.gov.au/newspubs/radio_TV/documents/RadioSpectrum.pdf, accessed on 29 January 2008.

80. Note: at the same time ACMA contemplated this action, it acknowledged that the availability and suitability of non broadcasting services band spectrum could be a factor in decisions about spectrum. *Spectrum for digital radio*, op. cit.

81. ACMA, ‘Spectrum restrictions for digital radio’, press release, MR44/2005, 9 November 2005, http://www.acma.gov.au/WEB/STANDARD/pc=PC_100296, accessed on 30 July 2008.

82. Digital Radio Australia, ‘How digital radio works’, http://www.digitalradioaustralia.com.au/index.cfm?page_id=1024, accessed on 30 July 2008.

Digital radio services in Australia will operate initially in VHF Band III, although the use of additional spectrum, such as L-band or parts of the spectrum between 230–240 MHz currently used by the Department of Defence, may be considered in the future.⁸³

Spectrum used by digital radio technologies

| <i>Spectrum use by technology</i> | | |
|-----------------------------------|--|------------------------------|
| <i>Technology</i> | <i>Service requirements</i> | <i>Preferred band</i> |
| Eureka 147 | Wideband – multiplexed 1.5 MHz channel per ensemble | VHF Band III, L-Band |
| DRM | Narrowband 9-18 kHz per channel | MF, HF |
| IBOC - AM - FM | Narrowband 20 kHz per channel 200 kHz per channel | MF VHF Band II |
| ISDB-TSB | Wideband - multiplexed 0.4 or 1.3 MHz per channel | VHF Bands II and III, UHF |
| DVB-T | Wideband – multiplexed 7 MHz per channel | VHF Band III, UHF |
| WorldSpace Satellite | Wideband – multiplexed 6 MHz Satellite/ 6 MHz Terrestrial | L-Band |
| US SDARS | Wideband – multiplexed 12.5 MHz | S-Band |

Source: DRSG⁸⁴

Step 3: the digital framework

In October 2005, the government announced a framework for the introduction of digital radio that mostly responded positively to a commercial radio industry wish list. The industry desire for the adoption of a full conversion policy was not fulfilled, however. The government opted instead for a supplementary approach noting that international examples indicated digital radio may not ever completely replace analogue services.⁸⁵ Under the digital framework, spectrum was to be made available to the national broadcasters and to wide coverage

83. In accordance with subsection 30 (2) (b) of the Radiocommunications Act 1992 the Australian Radiofrequency Spectrum Plan (ASRP) allocates the spectrum 230–240 MHz to be used principally for general purposes of defence.

84. Digital Radio Study Group, Report to the Minister for Communications, Information Technology and the Arts, March 2004, http://www.dbcde.gov.au/_data/assets/word_doc/23361/DSRG_report_March_2004.doc, accessed on 21 January 2008.

85. H. Coonan, (Minister for Communications, Information Technology and the Arts), *Framework for the introduction of digital radio*, media release, Parliament House, Canberra, 14 October 2005, http://www.minister.dcita.gov.au/coonan/media/media_releases/framework_for_the_introduction_of_digital_radio, accessed on 13 May 2008.

community broadcasters. Low powered community broadcasters and open narrowcasters were not included in the initial plan.⁸⁶

The commercial broadcasters welcomed the digital framework and committed to investing an estimated \$400 million in digital technology, but at the same time they noted:

There are some elements of this policy that need a lot more discussion. We want to ensure the amount of spectrum allocated to commercial radio allows us to provide the additional services and features that are necessary to take full advantage of the technology and drive consumer uptake.⁸⁷

Howard Government framework for introduction of digital radio

- The initial rollout of digital radio would involve existing licence holders for state capital commercial, national and wide-coverage community broadcasters. Introduction in regional areas would commence at a later stage.
- A moratorium would be introduced on the issue of new commercial digital radio licences for a period of six years following the introduction of digital radio services in state capital markets.
- Digital radio services would be subject to existing content regulation arrangements administered by ACMA.
- Broadcasters would not be required to simulcast their analogue service in digital.
- A new licence category would be established to enable non-radio broadcasters to make use of the digital radio platform to deliver non-radio services.
- Incumbent commercial (and if they chose, wide-coverage community broadcasters) in a licence area would have first right of refusal to elect jointly to manage the operations of multiplex ensembles and hold the associated spectrum licences. If they so elected, spectrum licences would be issued for an administrative charge only. A dedicated multiplex spectrum would be available to national broadcasters.
- Access rules would be established to ensure minimum levels of capacity on multiplex ensembles for commercial and wide-coverage community broadcasters.
- The Australian Competition and Consumer Commission (ACCC) would be given power to intervene to manage multiplex access, including addressing access disputes and anti-competitive conduct.
- Spectrum allocation and licensing would be managed by ACMA.⁸⁸

86. Narrowcasting services provide a wide range of innovative services, catering to specialised interest. Sections 17 and 18 of the Broadcasting Services Act 1992 define narrowcasting services as broadcasting services whose reception is limited by: being targeted to special interest groups; intended only for limited locations; provided during a limited period of time; because they provide programs of limited appeal or for some other reason. Subscription narrowcasting services differ from open narrowcasting services in that they are made available only on payment of subscription fees. Subscription or cable television is a narrowcast service, as are satellite radio and podcast services.

87. Commercial Radio Australia, *Industry welcomes digital announcement*, press release, 14 October 2005, http://www.commercialradio.com.au/index.cfm?page_id=1265#100241, accessed on 10 July 2008.

88. B. Jagers, *Broadcasting Legislation Amendment (Digital Radio) Bill 2007*, Bills Digest No. 142, Parliamentary Library, Canberra, 2006–07, <http://www.aph.gov.au/library/pubs/bd/2006->

Step 4: legislation

In March 2007, legislation was introduced into Federal Parliament to implement the government's digital radio plans. The legislation was referred to a Senate inquiry which agreed with previous assessments that the scarcity of spectrum was likely to create problems for the introduction of digital radio. The inquiry noted also that the need for broadcasters to co-operate in the use of a single data stream within multiplexes could bring another set of problems. It also acknowledged, and was sympathetic to concerns about the limitations of DAB technology in servicing regional and rural areas.⁸⁹ Nevertheless, despite these observations, a majority of the Senate committee supported the legislation. Amendments to the *Broadcasting Services Act 1992* to give effect to the digital radio framework were passed in May 2007.⁹⁰

Following the passage of the digital radio legislation, ACMA was given the task of developing and completing digital radio channel plans. These involved allocating blocks of frequency for use by multiplex operators in designated radio licence areas by the end of December 2007 to ensure that the legislated start date was achieved.⁹¹

At the same time as legislation was introduced into parliament, the radio industry announced that a new, superior standard for Eureka 147 technology, the DAB+ standard, had been developed and that this technology would be used when digital radio was launched in Australia. The first digital radio services were due to commence in the state capital city markets on 1 January 2009.

[07/07bd142.pdf](#), accessed on 13 May 2008. H. Coonan, (Minister for Communications, Information Technology and the Arts), *Framework for the introduction of digital radio*, media release, Parliament House, Canberra, 14 October 2005.

89. Senate Standing Committee on the Environment, Communications, Information Technology and the Arts, *Inquiry into Broadcasting Legislation Amendment (Digital Radio) Bill 2007 [Provisions] and Radio Licence Fees Amendment Bill 2007 [Provisions]*, May 2007, Senate Standing Committee on the Environment, Communications, Information Technology and the Arts, http://www.aph.gov.au/Senate/committee/ecita_ctte/completed_inquiries/2004-07/digital_radio/report/report.pdf, accessed on 28 July 2008.

90. See bills at [http://www.comlaw.gov.au/ComLaw/Legislation/Bills1.nsf/0/0403FA6E2A49519ACA2572AD007E7AE7/\\$file/07044B.pdf](http://www.comlaw.gov.au/ComLaw/Legislation/Bills1.nsf/0/0403FA6E2A49519ACA2572AD007E7AE7/$file/07044B.pdf) and [http://www.comlaw.gov.au/comlaw/legislation/bills1.nsf/0/DCEA1D48AF42102FCA2572AE0001CBCB/\\$file/07043B.pdf](http://www.comlaw.gov.au/comlaw/legislation/bills1.nsf/0/DCEA1D48AF42102FCA2572AE0001CBCB/$file/07043B.pdf) accessed on 19 March 2008. The Broadcasting Legislation Amendment (Digital Radio) Bill 2007 (the Digital Radio Bill) amended the *Broadcasting Services Act 1992*, the *Radiocommunications Act 1992* and the *Trade Practices Act 1974* to enable the licensing, planning and regulation of digital radio services and to give ACMA and the ACCC powers to undertake such activities. The Radio Licence Fees Amendment Bill 2007 complemented the Digital Radio Bill amending the *Radio Licence Fees Act 1964* to ensure that all revenue earned from analogue and digital radio broadcasting services is counted for the purposes of calculating radio broadcasting licence fees.

91. See these at the ACMA website http://www.acma.gov.au/WEB/STANDARD/pc=PC_310504, accessed on 28 July 2008.

Step 5: new government—same plans

In the 2007 election campaign, discussions of digital radio (and television) issues were largely conspicuous by their absence. In its first Budget since winning the November 2007 poll, the Rudd Government provided an option for broadcasters to delay commencement of digital radio transmission by six months. It noted at the same time that this extension did not prevent operators from commencing broadcast of digital radio services on 1 January 2009 as had been legislated by the previous government.⁹² There was initially some confusion about whether this announcement effectively delayed the launch of digital radio. The government insisted this was not its intention and a number of number of broadcasters indicated that they intended to commence digital transmission from 1 January.⁹³ However, this date has since been revised. May 2009 is now the expected start date for digital services in Sydney, Melbourne, Brisbane, Adelaide and Perth.⁹⁴

Radio in the 1930s and 1940s: the golden age or just the beginning?



Source: Cybercollege⁹⁵

The Future of Digital Radio

Overseas

Britain

Three years after the 1995 launch of digital radio in Britain by the British Broadcasting Corporation (BBC), a commercial operator, Digital One, also commenced a digital service.

92. Australian Government, *Budget Paper No 2: Budget Measures 2008–09*, Commonwealth of Australia, Canberra, 2008. p.101.

93. J. Hogan, 'Six-month delay for digital radio, the Age, 19 May 2008, <http://business.theage.com.au/business/sixmonth-delay-for-digital-radio-20080518-2flz.html>, accessed on 28 July 2008.

94. Digital Radio Plus, *Much improved digital radio channel plans*, media release, Sydney, 3 November 2008.

95. See article 'The golden age of radio', <http://www.cybercollege.com/frtv/frtv018.htm>

Until early 2008, the fact that a range of public and commercial digital stations had begun broadcasting in Britain led commentators to argue that there was a stark contrast between the British digital landscape and elsewhere. This view began to be questioned in February 2008 when GCap Media, a major stakeholder in Digital One, now one of the largest commercial digital operators in the world, announced the closure of two of its digital stations. Doubts surfaced about the future of digital radio in Britain as a consequence.⁹⁶

In announcing its decision, GCap contended that DAB was economically unviable because consumers gained nothing substantial from their digital listening experience in comparison with FM.⁹⁷ According to GCap, digital stations represented a niche interest as only four per cent of listening was to digital-only stations. FM on the other hand, according to GCap, was the backbone of the radio industry, comparable to all forms of digital technology in terms of quality and superior in terms of revenue.

This announcement led other commercial broadcasters to express similarly pessimistic views about the future of DAB radio technology, which they claimed has been superseded. Indeed, one broadcaster dubbed DAB as the Betamax of radio.⁹⁸ A report by the media research group Enders Analysis supported this view and argued further that the exodus of operators from the DAB platform was starting to look like a stampede.⁹⁹

GCap's denunciation of DAB needs to be tempered, however, by the knowledge that the operator was the subject of a takeover bid by Global Radio. It proposed to sell its digital radio operations not only as a cost cutting measure, but to fend off that bid.

And it is possible that the GCap decision has been premature and that it may not be indicative of the overall situation for digital radio in Britain. As one commentator notes:

DAB as a platform is not at fault [for the failure of one digital broadcaster]. It's the stations themselves that have shot themselves in the proverbial foot. Yes, we've lost a number of radio stations on DAB, but they've closed because their business plans were not realistic, in

96. See background on GCap at ketupa.net website, <http://www.ketupa.net/gcap.htm>, accessed on 31 July 2008.

97. J. Plunkett, 'Hazlitt: DAB radio "not economically viable"', *guardian.co.uk*, 11 February 2008, <http://www.guardian.co.uk/media/2008/feb/11/gcapmedia.digitaltvradio>, accessed on 22 July 2008.

98. Quote from Richard Wheatley, the chief executive of the Local Radio Company in J. Plunkett, 'Is DAB radio the next Betamax?' *guardian.co.uk*, 29 January 2008, <http://www.guardian.co.uk/media/2008/jan/29/radio.digitaltvradio?gusrc=rss&feed=media>, accessed on 31 July 2008.

Note: Betamax and VHS video standards were introduced in the mid 1970s. For around a decade, the two standards battled for market dominance, but eventually VHS emerged as the winner. While Betamax is generally considered to have been a better format, several factors, such as the better marketing of VHS, the fact that VHS machines were cheaper to manufacture and the initial shorter recording time span of Betamax tapes contributed to the demise of the Betamax technology.

99. Enders Analysis report, *DAB radio—nice platform, shame about the takeover*, 2008, reference in Plunkett, op. cit.

much the same way that a multitude of stations have closed on digital television, not because of the platform, but because their business plans were not realistic, not designed for the new digital broadcast environment that exists these days.¹⁰⁰

While it can be argued in justification of the GCap decision that the take up of digital radio in Britain has been slow in real terms, at the same time it is obvious that a considerable public investment in digital radio is beginning to pay dividends. Sales of DAB receivers have recently outstripped sales of analogue radios and it is expected that there will be over nine million digital sets in British homes by the end of 2008. British radio listening statistics indicate that currently almost 30 per cent of British adults own a digital radio and 18 per cent of all radio listening is to digital radio in its various forms.¹⁰¹

Additionally, the development of more affordable digital receivers has helped to change the listening habits of many Britons and as digital radio has become available through Freeview television, a new audience has been exposed to digital radio via television set-top boxes.¹⁰²

Furthermore, while GCap has expressed a lack of confidence in the future of digital radio, the 4 Digital Group owned by Channel 4 television has acquired Britain's second commercial radio multiplex, which is expected to go to air by the end of 2008. The Group intends to run ten national radio services, which it is promoting as viable alternatives to the BBC.¹⁰³

It could be argued that while the BBC and 4 digital will be competitors, a cooperative spirit also exists between the two broadcasters which represents not only a commitment to the future of digital radio in Britain, but also to securing Britain's 'position in the forefront of digital radio development'.¹⁰⁴ At the same time, it should be noted that while Channel 4 is commercially funded, unlike other commercial stations, it is publicly owned. Its remit is to provide an alternative public service broadcast service to that delivered by the BBC. The sceptical may therefore consider that in view of ongoing financial difficulties experienced by

100. I. Beaumont, 'Dead and buried?' *Radiomusications*, Transdiffusion Broadcasting system 2008, http://www.transdiffusion.org/rmc/digital/dead_and_buried.php, accessed on 22 July 2008.

101. Radio Joint Audience Research Limited (RAJAR) Press conference release of Quarter 1, 2008 listening statistics, May 2008, http://www.rajar.co.uk/docs/2008_03/2008_Q1_Platform_Digital_Mobile_mp3.pdf, accessed on 23 July 2008. It should be noted that DAB digital listening represents 10.8 per cent of this figure.

102. Digital Radio Ltd website, 'DAB UK' <http://www.digitalradioltd.com/dab-uk/>, accessed on 23 July 2008. Note: Freeview is managed by DTV Services Ltd, a company owned and run by its five shareholders—BBC, BSkyB Channel 4, ITV and National Grid Wireless. Launched in October 2002, the Freeview service provides free-to-air digital television channels, radio stations and interactive services through an aerial.

103. See the 4 Digital Group bid at its website <http://www.channel4.com/radio/4digital/index.html>, accessed on 23 July 2008.

104. BBC Press Office, 'BBC and 4 Digital Group confirm their commitment to develop digital radio', BBC website, 11 February 2008, http://www.bbc.co.uk/pressoffice/pressreleases/stories/2008/02_february/11/dab2.shtml, accessed on 31 July 2008.

Channel 4, the digital radio proposal is somehow associated with its efforts to secure some form of supplementary public funding support.¹⁰⁵

Canada

Predictions about the future of digital radio in Canada are difficult to make. Indeed, it has experienced many difficulties since the DAB standard was first introduced in 1998 and currently many commentators consider it has ‘stalled’.¹⁰⁶ A 2006 review by the Canadian Radio-television and Telecommunications Commission (CRTC) outlined some of the reasons for this situation. These included: limited availability and high cost of digital receivers, a lack of unique digital programming and the lack of a contiguous digital coverage between major Canadian urban centres. This latter situation resulted in listeners being more inclined to use United States subscription satellite services than free, terrestrial Canadian stations.¹⁰⁷ The high cost of receivers, while not solely a Canadian phenomenon, was compounded in Canada by a decision to broadcast in the higher L Band frequencies rather than Band III VHF which has been chosen by most other countries. Additionally, a requirement for receivers to accommodate French and English displays of information also added to the cost of Canadian digital receivers.

A further reason could be added: a policy decision that digital radio would be a replacement technology for AM and FM. This decision in turn led to assumptions that a ‘rapid transition’ to digital would occur. As a result of these assumptions, inflexible transitional regulations were imposed on broadcasters which prevented the introduction of new programming and content options—the major selling points for audiences.¹⁰⁸

But Canada’s digital woes have been compounded most severely by the United States’ decision to adopt a digital standard which is incompatible with DAB—IBOC (see earlier discussion on other digital radio systems and further comment in the following section).¹⁰⁹ As a consequence:

... there now appear to be only token efforts underway to promote the digital radio services that have been launched. As well, there has been little investment in the building and

105. Channel 4 has experienced difficulty in financing the switchover to digital broadcasting seeking approximately 14 million pounds in public subsidy. This has recently been rejected and plans are in place to review funding for the broadcaster under the Digital Britain review proposed for 2009. C. Tryhorn, ‘Government ditches plans to give Channel 4 £14m digital switchover help’, *guardian.co.uk*, 26 November 2008, <http://www.guardian.co.uk/media/2008/nov/26/channel4-digital-switchover>, accessed 28 November 2008.

106. The argument that digital has stalled in Canada is put at Canadian Radio-television and Telecommunications Commission (CRTC), *Digital Radio Policy*, Broadcasting Public Notice CRTC 2006–160, Ottawa, 15 December 2006, <http://www.crtc.gc.ca/archive/ENG/Notices/2006/pb2006-160.htm>, accessed on 23 July 2008.

107. Digital Radio Coordinating Group, *IBOC technology: An assessment of technical and operational issues in the Canadian FM environment*, CRTC, 24 May 2007, http://www.cab-acr.ca/english/radio/dab/DRCG_Report_final.pdf, accessed on 23 July 2008.

108. O’Neill, op. cit., p. 82.

109. Digital Radio Coordinating Group, op. cit.

operation of digital radio transmission facilities outside of the markets where these services were initially established. Some stations that began broadcasting in digital have ceased operations.¹¹⁰

Initial support from the commercial broadcasting industry in Canada for the DAB radio technology was withdrawn following the American decision to implement IBOC and unlike the BBC, the Canadian national broadcaster has adopted a low profile in promoting DAB technology.¹¹¹ While this is the case, and while the future of DAB as the one source of digital radio in Canada looks insecure, one commentator notes that recent indications are that a ‘host’ of other standards are being considered.¹¹²

United States

In the United States, digital radio per se appears to be relatively successful. But terrestrial digital radio is in its infancy and is faced with the task of competing with an established satellite digital industry which has been attracting customers since 2002. There are over eighteen million subscribers to the two American satellite operators XM and Sirius; for a small monthly subscription fee to these operators, audiences have access to over 300 radio channels.¹¹³ But while the numbers of satellite digital radio subscribers in America continue to increase, these operators have not found this form of broadcasting as lucrative as they would have hoped. Both companies are in debt for nearly three billion dollars as a result of high infrastructure costs and expensive programming decisions.¹¹⁴

There are two opposing views of how successful the promotion of terrestrial digital radio has been in the American context. The parent company for IBOC iBiquity argues on the one hand that HD radio has been embraced by Americans with almost 1800 digital stations covering more than 80 per cent of the population and that 50 per cent of radio listening takes place on stations that have converted to digital. It adds that many of the major car manufacturers which previously only offered satellite radios in vehicles, have equipped, or intend to equip at least some of their models with HD radio.¹¹⁵

110. CRTC, op. cit.

111. O’Neill, op. cit., p.80.

112. *ibid.*

113. There are 18 921 911 subscribers according to the Sirius XM quarterly report, United States Securities and Exchange Commission, Quarterly Report Pursuant to Section 13 or 15 (d) of the Securities Exchange Act of 1934, for the period ended September 30 2008.

114. The *Sydney Morning Herald* reported debts of nearly \$3 billion in July 2008 as Sirius attempted a takeover of XM. ‘Analysts: Tough conditions won’t kill radio deal’, *smh.com.au*, 18 July 2008, <http://news.smh.com.au/technology/analysts-tough-conditions-wont-kill-radio-deal-20080718-3h41.html> and C. Kang, ‘XM radio predicts quarterly loss even as its customer base grows’, *washingtonpost.com*, 22 July 2008, p. D06, <http://www.washingtonpost.com/wp-dyn/content/article/2008/07/21/AR2008072102371.html>, accessed on 24 July 2008.

115. B. Struble, ‘Thoughts on radio’s digital future’, Ibiquty website, http://www.ibiquity.com/about_us/message, accessed on 1 August 2008.

There are those who disagree with this assessment, however. *Washington Post* journalist Marc Fisher for one argues that after two years of intensive ‘promotion and hype’ HD radio has failed to convince audiences that it is a better option than subscription radio or other listening options, such as iPods. Fisher considers:

Listeners are voting with their ears, and they’re choosing Web-based and mobile audio, in part because most HD radio programming just isn’t compelling enough to lure people to a different gadget.¹¹⁶

Similar criticism is that HD services are not making an impression on American listeners because they amount to ‘automated jukebox services’ providing no added value.¹¹⁷

Australia

The question of interest

As noted previously in this paper, the Australian Government has explored digital radio options since the early 1990s and successive Ministers in the communications portfolio have declared support for the new face of radio.¹¹⁸ As academic Jock Given notes, however, while plans for the introduction of digital television and radio were announced simultaneously in 1998 and free-to-air television services started on time in major cities in 2001:

Digital radio dropped off the agenda. Commercial stations couldn’t see where the extra revenue was going to come from to pay for the transmission infrastructure. The ABC couldn’t imagine a hostile government giving it more money for anything. Non-profit community radio stations were flat out paying for the technology they already had.¹¹⁹

While Given’s assessment that the ABC (and SBS) experienced financial restraints in relation to the introduction of digital radio and in providing other services, both public broadcasters have expressed long-standing commitments to digital radio. In particular they have expressed a commitment to developing digital technologies which are able to provide the best available services for all Australian audiences.¹²⁰

-
116. M. Fisher, ‘HD: if a tree falls and no one hears it ...’, *washingtonpost.com*, 10 February 2008, <http://www.washingtonpost.com/wp-dyn/content/article/2008/02/08/AR200802081035.html>, accessed on 1 August 2008.
 117. ‘Digital radio takes some knocks’, ABC Digital Futures website, 12 February 2008, <http://www.abcdigitalfutures.net/?p=1321>, accessed on 1 August 2008.
 118. For example, H. Coonan, (Minister for Communications, Information Technology and the Arts), *Digital radio to be introduced by 2009*, media release, Parliament House, Canberra, 4 April 2006.
 119. J. Given, ‘Has radio blown the future?’ Creative Economy Online, 21 February 2008, http://www.creative.org.au/webboard/results.shtml?filename_num=197093, accessed on 23 July 2008.
 120. See for example, the ABC’s *Submission to the Inquiry into the introduction of digital radio*, April 2005, in which the Corporation states its long term commitment to digital radio, http://www.abc.net.au/corp/pubs/documents/ABC_Submission_Introduction_of_Digital_Radio_Apr_05.pdf, accessed on 24 July 2008.

Despite rhetoric that is mostly to the contrary, the extent to which the commercial radio industry has supported digital technology is debatable. Media commentator Mark Day argued in 2003 that the Australian radio industry was not interested in converting to digital. Day considered that the industry had actually resisted the introduction ‘because the new technology unsettles a cosy industry which puts the maintenance of its profits and its pecking orders before the provision of services to the public’.¹²¹ While there may be some merit in this assessment, it would be unrealistic to expect a commercial industry to act purely from an altruistic standpoint—commercial radio expects returns from substantial investment and digital radio has entailed a substantial investment.¹²²

In monitoring the development of digital radio internationally, the commercial broadcasting services would justifiably have been concerned about the prohibitive cost of receivers, debates about technology options, technology glitches and the apparent lack of consumer interest. This may be because the profile of digital radio has been relatively low, particularly in comparison with digital television. Research indicates that audience interest is increasing with the most recent survey undertaken by Commercial Radio Australia in 2006 (see the results in figure below) indicating that 75 per cent of Australians surveyed would consider purchasing a digital radio.¹²³ At the same time, it is interesting to note how dated this survey is and the lack of promotion of digital radio by the industry itself, given that the introduction of the technology is fast approaching.

Digital radio purchase interest February 2006.

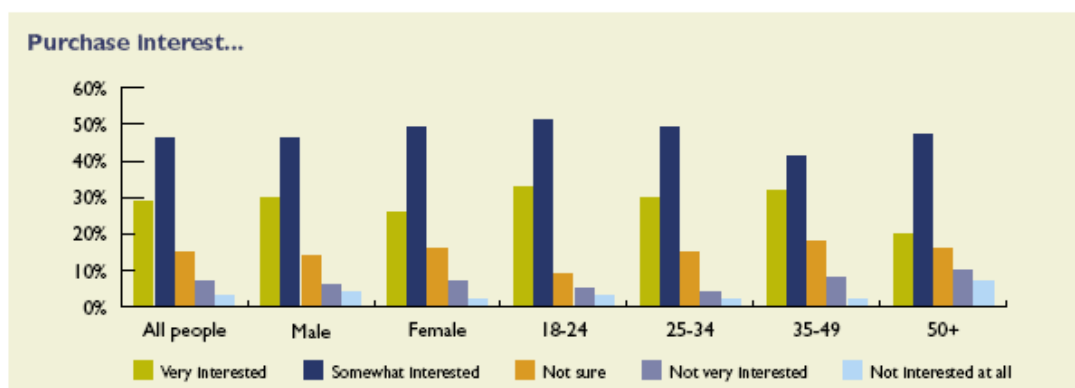

Source: Colmar Brunton Media Solutions

Source: Commercial Radio Australia¹²⁴

121. M. Day, ‘Incumbents can’t dither on digital’, *Australian*, 20 November 2003, p. 6.

122. Reportedly, the introduction will cost between \$350 and \$400 million. See for example W. Frew, ‘Problem of digital radio: is there money in it?’ *Sydney Morning Herald*, 19 January 2004, p. 29 which cites \$350 million as the figure.

123. Commercial Radio Australia, Digital radio. The next generation of radio is coming to Australia, brochure at CRA website, http://www.digitalradioaustralia.com.au/files/uploaded/file/Digital_Radio/Digital%20Radio%20Brochure.pdf, accessed on 24 July 2008.

124. *ibid.*

Technology uncertainties

The issue of which digital standard is the most effective for the delivery of digital radio services, and in the Australian context, which is the most appropriate to deliver services to both metropolitan areas and vast rural and regional areas, will continue to be pertinent.

The Australian radio industry has consistently supported the adoption of DAB technology for digital radio. A number of studies have cautiously agreed with this industry support that DAB is the most ‘mature’ of the digital radio technologies and at present the one that can most readily provide audiences with affordable receivers. At the same time however, there were inherent problems with the original DAB system that led broadcasters and governments from numerous countries to oppose adoption of the system and which most probably forced WorldDMB to upgrade to DAB+. But while DAB+ offers improved spectrum efficiency, arguably lower station transmission costs and a greater choice of services, it does not improve geographical coverage significantly.

In recognition of the problems associated with geographical coverage, the Howard Government’s 2007 legislation provided for the undertaking of a review of technologies for the transmission of digital radio broadcasting services in regional areas by 1 January 2011. The review is intended to allow for the consideration of issues, such as availability and price of reception equipment and the geographical coverage of the various digital radio technologies. The Department of Broadband, Communications and the Digital Economy notes that one technology to be considered in the context of the review will be DRM. The Department adds however, that ‘DRM is not a widely deployed technology and only a limited range of consumer receivers are currently manufactured’.¹²⁵ So it could be surmised that there is an inherent bias in favour of DAB that may be difficult for policy makers to overcome.

Given that the adoption of digital radio has not been high on the government agenda and that finding the most appropriate technology to accommodate vast geographical expanses was always going to be an issue for Australia, it may be that the question of whether it would be wiser to wait and see before committing to DAB technology should have been more forcefully put. And it may be that the wait would not have been substantial. A consortium is currently developing the DRM technology to improve its capabilities, for example, with one DRM+ test project extending the regular DRM system (which previously applied to radio frequencies below 30 MHz) to allow FM stations in the 87.5 MHz to 108 MHz frequency range to broadcast in digital.¹²⁶ It may not be that long therefore before a hybrid DAB–DRM system has been fully tested and is functional and Australia will have committed its limited resources to an outdated technology.

125. Department of Broadband, Communications and the Digital Economy, ‘Rollout of digital radio in Australia’, http://www.dbcde.gov.au/media_broadcasting/radio/digital_radio/rollout_of_digital_radio_in_australia, accessed on 21 July 2008.

126. Digital Radio Mondiale Consortium, *Positive tests from DRM+ tests on FM*, press release, 29 May 2008, http://www.drm.org/uploads/media/290508_Positive_Results_From_DRM_Tests_on_FM_E.pdf, accessed on 21 July 2008.

In some quarters the question of whether digital radio is itself an outdated technology has also been raised.¹²⁷ It can be argued from this perspective that other significant developments in audio technology, which have emerged since the introduction of digital radio was first mooted in Australia, have made the technology redundant. Internet radio for example is advertised as providing listeners with more choice than digital radio as there are thousands of stations available on the Net and these stations broadcast in an increasing number of genres. Internet personalised stations which attempt to predict what music listeners may like based on their previous listening preferences are even available to Internet radio audiences and Wi-Fi systems can be added to make their listening experience portable.¹²⁸

Despite the considerable research undertaken in Australia into the digital radio phenomenon there was no consideration of the possibility that other types of audio technologies could emerge as challenges. The fact that these technologies have emerged and, more importantly, that there is a distinct possibility that their audiences may not be seduced by digital radio, has indeed changed the landscape into which digital radio will launch in 2009.

This paper does not attempt to discuss the issues of whether the features of technologies such as Internet radio are superior to digital and if they do indeed make digital radio obsolete. But it is clear that this 'technology' issue, combined with what appears to be a lack of audience interest at present, may well be vital contributing factors to the success or failure of digital radio in Australia.

Cost and availability of digital radios

Most major manufacturers have produced DAB receivers for sale and there are currently over 980 different receivers on the international market. In Europe, prices start from 32 Euros with manufacturers claiming there is a make and model for every need and taste.¹²⁹

According to Digital Radio Australia, PURE Digital's The Bug (see below) is one of the most sophisticated digital radios currently available. Marketing for the radio says it almost comes alive when switched on, 'thanks to its "blinking eyes" display'.¹³⁰ In Europe, The Bug retails for approximately 220 Euro (around \$450). It will be interesting to see what it will retail for in Australia and the extent to which Australian audiences are prepared to pay for this sophisticated listening experience.

127. See footnote 116.

128. See for example some of these stations at the <http://www.shoutcast.com/> Internet portal. One example of a personalised station can be seen at <http://www.last.fm/>, accessed on 28 November 2008.

129. Digital Radio Australia, http://www.digitalradioaustralia.com.au/files/uploaded/file/Digital_Radio/features%20and%20feedback.pdf and http://www.digitalradioaustralia.com.au/files/uploaded/file/Digital_Radio/Retailers/Receiver_Guide.pdf, accessed on 21 July 2008.

130. Digital Radio Australia description of features of this radio is at http://www.digitalradioaustralia.com.au/files/uploaded/file/Digital_Radio/features%20and%20feedback.pdf, accessed on 21 July 2008.

It appears no Australian retail outlets currently stock digital radios. Consumers are able to order receivers from manufacturers such as PURE Digital.¹³¹



Source: Digital Radio Australia¹³²

How will community broadcasting fare?

With 353 long term licensed community radio stations, and 84 long term licensed community television stations, which include 80 remote Indigenous community television stations as well as other stations currently operating on temporary licenses, community broadcasting is Australia's largest and most diverse media sector.¹³³ Community stations are not permitted to accept advertising and are 'largely self-financed, drawing support from the communities [they serve] via sponsorship, subscriptions, donations and general fundraising'.¹³⁴ Community stations receive some funding from the government, but not enough to fund a transition to digital radio without extra government support.¹³⁵

131. See PURE digital website, <http://www.puredigital.com/>, accessed on 28 August 2008.

132. Digital Radio Australia, op. cit.

133. See long term radio licence and television licence details at the ACMA website http://www.acma.gov.au/webwr/assets/main/lib100052/lic007_community_of_interest.pdf and http://www.acma.gov.au/webwr/assets/main/lib100052/lic032_community_tv_broadcasting_licences.pdf and temporary radio licence details http://www.acma.gov.au/webwr/assets/main/lib100052/lic032_community_tv_broadcasting_licences.pdf, accessed on 15 July 2008. There are two temporary community television licences issued in Adelaide and Lismore.

134. Australian Government funding for community broadcasting in 2006–07 totalled \$7.8 million. House of Representatives Standing Committee on Communications, Information Technology and the Arts, *Tuning in to community broadcasting*, House of Representatives Standing Committee on Communications, Information Technology and the Arts, June 2007, p. 33.

135. Australian Government funding for community broadcasting in 2006–07 totalled \$7.8 million. *Tuning in to community broadcasting*, op. cit., p. 33.

Following the government's announcement of the digital radio transmission framework in January 2006, the Community Broadcasting Association of Australia (CBA) sought funding of approximately \$15 million for the new infrastructure that community radio would need for digital content aggregation, contribution and transmission carriage via digital radio technology.¹³⁶ The government responded in the 2007 Budget with an allocation of \$10.5 million to be distributed over four years.¹³⁷

In a submission to the Senate inquiry into the digital radio legislation in 2007 the CBA raised a number of concerns about how the legislative framework for transition to digital would affect community broadcasting. The first concern was that the legislation did not provide capacity for community radio broadcasting services on all available multiplexes, which had previously been guaranteed in the Howard Government's digital radio framework. Secondly, the CBA expressed concern about the collaborative management structure that would be imposed on wide-coverage community radio broadcasters by way of a 'digital representative company'.¹³⁸

Under this structure, Digital Representative Companies were to determine how the community radio stations in each city collectively and collaboratively accessed digital spectrum. The companies were also required to become shareholders with commercial radio licensees in joint venture companies that would own and operate transmission multiplexes.

The Senate inquiry was not overly sympathetic to the community sector's concerns, noting that:

- 'all participants in this new broadcasting regime need to recognise that a complicated set of policy objectives are being pursued under some difficult technical constraints'
- it was possible that the sector's concerns were unduly pessimistic and

136. Community Broadcasting Association of Australia, *Adding digital value*, January 2006, <http://209.85.141.104/search?q=cache:m-ZSzkRrfqcJ:www.cbaa.org.au/download.php%3Fid%3D2549+adding+digital+value&hl=en&ct=clnk&cd=1&gl=au>, accessed on 15 July 2008.

137. H. Coonan, (Minister for Communications Information Technology and the Arts), *\$10.5 million for community and national digital radio broadcasting*, media release, Parliament House, Canberra, 8 May 2007, [http://www.minister.dcita.gov.au/coonan/media/media_releases/\\$10.5_million_for_community_and_national_digital_radio_broadcasting](http://www.minister.dcita.gov.au/coonan/media/media_releases/$10.5_million_for_community_and_national_digital_radio_broadcasting), accessed on 15 July 2008.

138. Submission by CBA to the Senate Standing Committee on Environment, Information Technology and the Arts, Broadcasting Legislation Amendment (Digital Radio) Bill 2007 [Provisions], Radio Licence Fees Amendment Bill 2007 [Provisions], May 2007, http://www.aph.gov.au/Senate/committee/ecita_ctte/completed_inquiries/2004-07/digital_radio/submissions/sub05.pdf, accessed on 13 May 2008.

- access issues may only be relevant if there was less bandwidth than desired for enough multiplexes to meet the interests of all existing broadcasters wanting to commence digital broadcasting.¹³⁹

Despite the Senate's relatively unsympathetic response, the CBAA's concerns about the sector's viability were real and prompted by a number of factors. The most pressing of these was that as the majority of the community broadcasting sector functions on 'shoestring' budgets, the cost of digital conversion was beyond their ability to fund either collectively or individually.

The Digital Radio Bill was passed without changes to the company provisions, however. This meant that eligible metro-wide community radio stations had to elect to join a digital representative company by 9 April 2008. These companies needed to join with joint venture companies by 21 April 2008 and joint venture companies were required to apply for multiplex apparatus licenses by 9 May 2008.¹⁴⁰

Following the 2007 election, the CBAA petitioned the Rudd Government to bring forward \$2.4 million of the funding promised by the previous government to help the community sector to comply with these deadlines. When the government did not respond by the April 2008 deadline, media commentator Margaret Simons made the point:

Without signing [to establish joint venture companies], community radio risks being locked out of the discussions that will guide the future of digital radio. Yet signing meant making major financial commitments to companies effectively managed by the commercial radio stations, without any clarity on the potential liabilities in the future.

Around the country community radio has been scraping the bottom of the till to find the money to sign up. Some stations simply haven't been able to pay their share, and are either locked out or else being subsidised by others.¹⁴¹

Simons was of the opinion that even those community stations that managed to join joint venture companies would be dominated within the companies by commercial radio members and further disadvantaged by the fact that they would receive access to significantly less spectrum than the commercial sector.¹⁴² It could be argued on the one hand that such a situation is only fair, given that community radio is a specialised service which attracts a smaller audience than commercial radio. A counter argument could be advanced that in an era of increasing media concentration and simulcast of information, community radio makes

139. Senate Standing Committee on Environment, Information Technology and the Arts, Broadcasting Legislation Amendment (Digital Radio) Bill 2007 [Provisions], Radio Licence Fees Amendment Bill 2007[Provisions], May 2007, http://www.aph.gov.au/Senate/committee/ecita_ctte/completed_inquiries/2004-07/digital_radio/report/report.pdf, accessed on 13 May 2008.

140. See the invitation to apply for licences on the ACMA website http://www.acma.gov.au/WEB/STANDARD/pc=PC_310503, accessed 15 July 2008.

141. M. Simons, 'Will digital kill the community radio star?' 22 April 2008, <http://www.crikey.com.au/Media-Arts-and-Sports/20080422-Will-the-digital-radio-sign-up-kill-the-community-radio-star.html>, accessed on 11 July 2008.

142. *ibid.*

a significant contribution by delivering local content. So providing it with better access to broadcasting capacity could enhance media diversity and the value of community broadcasting. Similarly, it could be argued that as community broadcasting is a major training ground for journalists and technicians in the radio industry, it deserves more consideration in the allocation of digital resources.

There was no funding provided to assist the community radio sector in transferring to digital technology in the 2008–09 Budget, but it appears that funding of \$11.2 million provided over three years has been set aside from the 2009–10 financial year.¹⁴³ The President of the CBAA has been quoted as being relieved that this funding will give community radio some sort of ‘digital future’.¹⁴⁴

But it is by no means clear whether that digital future will remain limited only to the ‘wide coverage’ stations or whether it may extend to all community broadcasters.

Conclusion

Throughout the 1990s and the early 2000s digital radio in its various forms was consistently promoted as the future of radio, but a number of commentators consider the development of other technologies have made the need for digital services redundant. It appears also that lack of commercial support for digital services, funding problems and lack of public interest in some overseas countries provide the basis for an argument that the future of digital radio, at least in some forms, may be questionable. In the Australian context, the development of digital radio has involved a sometimes tortuous parade of reports and recommendations, attitudes which have been considered as ranging from indifferent to wholehearted support by the radio industry and government and a similar lack of real interest from the public to that seen overseas. Because digital radio has been a long time coming to Australia some commentators have reported that many in the local industry also believe it will be ‘stillborn’. One argues that digital radio is ‘going nowhere’:

It may have seemed like a good idea a decade ago, but digital radio is simply not important or relevant anymore. It is a ‘me-too’ effort of the grandest scale, a redundant, pointless exercise born more from the industry's desire not to be left behind, than from any real need.¹⁴⁵

This argument can be supported by the very fact that AM and FM radios are the established ‘face’ of radio. AM and FM are what people listen to—in cars, homes, boats, offices. There is

143. Community Broadcasting Foundation (CBA) website, ‘Sector funding 2008–09’, <http://www.cbf.com.au/Content/templates/news.asp?articleid=286&zoneid=16>, accessed on 21 July 2008. The CBA reports: ‘There will be a one-year delay in funding for digital radio. That is —no funding in 2008–09 but an \$11.211 million commitment over the subsequent three years phased as \$6.906 m in 2009/10, \$2.129 m in 2010–11, and \$2.176 m in 2011–12’.

144. ‘A mixed bag in the budget for community broadcasters’, 16 May 2008, CBAA website, http://www.cbaa.org.au/content.php/236.html?newsid=1302&refpg=1&refid=346#mod_346_top accessed on 21 July 2008.

145. D. Braue, ‘Internet killed the (digital) radio star’, 19 June 2008, ZDNet Australia website, http://www.zdnet.com.au/blogs/fullduplex/soa/Internet-killed-the-digital-radio-star/0,139033349,339289967,00.htm?feed=pt_fm_radio, accessed on 31 July 2008.

no time, according to this assessment, to convince people to replace their traditional receivers with digital alternatives and change their listening habits before next generation Internet radio and 3G mobile phones make digital radio irrelevant.

Yet despite this pessimism, digital radio is surviving in significant markets—just as AM radio survived the advent of FM and radio itself survived the advent of television.¹⁴⁶ With the appropriate support and promotion, digital radio, like the ‘second coming’ of FM in the 1970s, may yet be successful in Australia. There remain questions, however, about whether having waited so long to introduce digital radio into a limited market, the particular technology chosen is outdated, as well as questions about how some sectors of the industry will negotiate the digital landscape.

Glossary

Analogue radio: Analogue refers to the process of taking an audio or video signal and translating it into electronic pulses for transmission. As analogue signals are continuously variable, traditional radio has used two types of broadcasting modulation—amplitude modulation (AM) and frequency modulation (FM)—to mix audio signals with a carrier signal for transmission.

Amplitude modulation (AM): Amplitude modulation is the method of combining radio carrier waves and electric waves so that the amplitude of the carrier waves varies to match the change in the electric waves. The AM band of the electromagnetic spectrum is between 535 and 1705 KHz.

146. Radio ratings for 2008 for example show an audience of 8.7 million people ten years and over listen to commercial radio each week for an average of per week of 16 hours and 48 minutes. Commercial Radio Australia report of ratings period four 2008, http://www.commercialradio.com.au/files/uploaded/file/Survey%202008/Survey%204,%202008%20Summary_2.pdf and in a 2006 report, ACMA notes that while there has been a shift of listeners from AM to FM, at the same time, talk formats on metropolitan AM radio perform relatively well in terms of audience share and profitability, ACMA, *AM radio issues. An examination of technical and engineering issues, their impact on the AM radio business model, and digitalisation*, Sydney, January 2006, http://www.acma.gov.au/webwr/assets/main/lib100068/amradio_issues.pdf, accessed on 31 July 2008.

AM Radio

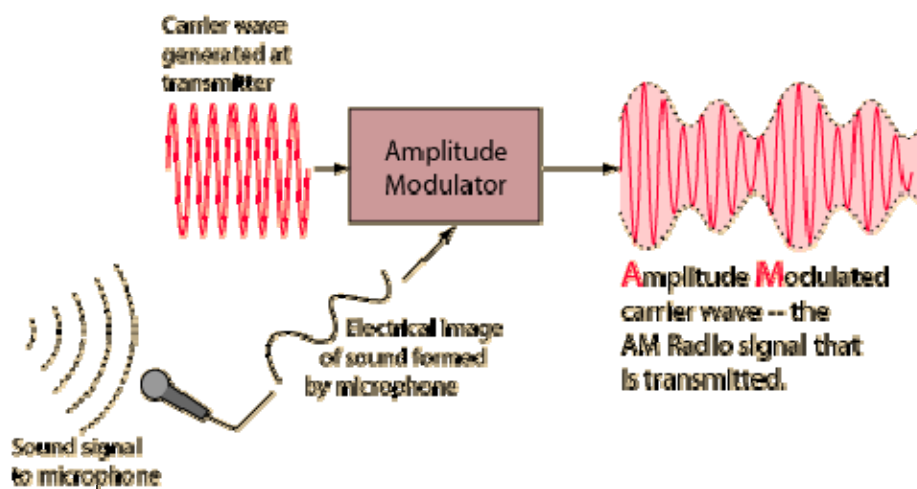

Band: the range of radio frequencies which are between two defined limits and which are used for a specific purpose.

Bandwidth: In electronic communication, bandwidth is the width of the range (or band) of frequencies that an electronic signal uses on a given transmission medium. Bandwidth is expressed in terms of the difference between the highest-frequency signal component and the lowest-frequency signal component. The frequency of a signal is measured in hertz (the number of cycles of change per second), so a given bandwidth is the difference in hertz between the highest and the lowest frequency the signal uses. A typical voice signal has a bandwidth of approximately 3 kHz and an analogue television broadcast video signal has a bandwidth of 6 MHz, some 2000 times as wide as the voice signal.

Carrier wave: a radio wave that can be modulated in order to transmit a signal.

Coded Orthogonal Frequency Division Multiplex (COFDM): COFDM is a modulation scheme that divides a single digital signal across 1000 or more signal carriers simultaneously. The signals are sent at right angles to each other so they do not interfere with each other. COFDM can overcome multipath effects which occur when a signal meets obstructions such as buildings.

Codec: a codec is a device or program capable of encoding and decoding on a digital data stream or signal.

Data compression: encoding data for transmission or storage using fewer bits.

Digital Audio Broadcasting (DAB) radio: DAB radio works by combining two digital technologies, Masking Pattern Adapted Universal Sub-Band Integrated Coding and Multiplexing (MUSICAM or MPEG layer 2 or MP 2) and Coded Orthogonal Frequency Division Multiplex (COFDM). MP 2 technology compresses digital information to be broadcast by discarding sounds that will not be perceived by listeners and packaging together information that remains for transmission. COFDM ensures that the digital signals are received, even in environments normally prone to interference.

Dab+: Dab+ uses a more compression efficient audio coding standard than DAB—HE-AAC v2 (also known as MP4 or AAC+). This standard allows for the equivalent or better subjective audio quality to be broadcast at lower bit rates than DAB is able to achieve. DAB+ is supposedly more spectrum efficient than DAB as more stations can be broadcast on a multiplex, less transmission cost is incurred per station and a wider choice of stations becomes available. The geographical coverage area for DAB+ is slightly greater than DAB.

Digital radio format: Digital involves breaking an audio or video signal into a binary format where the audio or video data is represented by a series of 1s and 0s. Because digital signals are made up only of binary streams, less information is needed to transmit a message. Digital encoding increases the capacity of a radio frequency. Only digitized information can be transported through a noisy channel without degradation but even if some corruption occurs to a digital format, as long as the one-zero pattern is recognizable, original information content can be perfectly replicated at the receiving end.

Digital Radio Mondiale (DRM): is a set of digital radio broadcasting technologies designed to work over the bands currently used for AM broadcasting. DRM can fit more channels than AM (at higher quality) into a given amount of bandwidth, using various MPRG 4 codecs.

Digital Video Broadcasting—Terrestrial system (DVB—T): The Digital Video Broadcasting—Terrestrial (DVB—T) system has been deployed in many countries, including Australia, within existing broadcasting service band allocations, including VHF Band III, and UHF Bands IV and V. As with the Eureka system, the use of DVB—T for digital radio requires programs to be multiplexed together at a central point prior to transmission.

DVB—T is used to provide services to fixed receivers and while it is technically capable of being received with mobile receivers, it is not optimised for mobile reception.

Electromagnetic spectrum: The electromagnetic spectrum is a continuum of all self propagating radiation waves arranged according to frequency and wavelength.

The Electromagnetic Spectrum

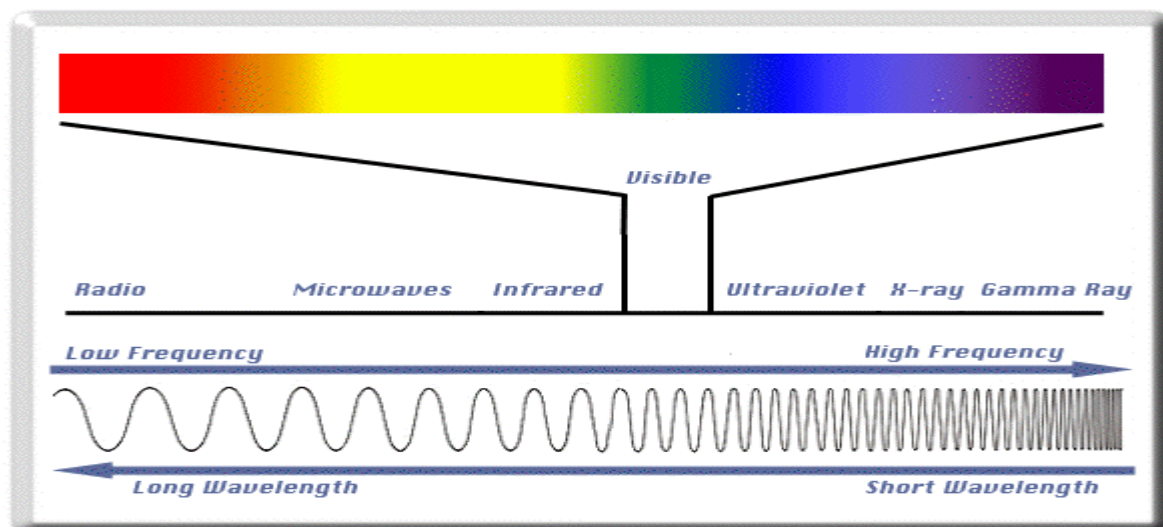

Frequency: relates to the basic pitch of a sound. Frequency is measured in Hertz (Hz) or cycles per second (CPS). A person with exceptionally good hearing will be able to hear sounds from 20 to 20,000Hz. A frequency of 20 Hz would sound like an extremely low-pitched note on a pipe organ whereas 20,000 Hz would be the highest pitched sound that can be imagined, higher than the highest note on a violin.

| Frequency | Description |
|------------------|----------------------------|
| 30 - 300 GHz | Extremely High Frequency |
| 3 - 30 GHz | Super High Frequency |
| 300 MHz - 3 GHz | Ultra High Frequency (UHF) |
| 30 - 300 MHz | Very High Frequency (VHF) |
| 3 - 30 MHz | High Frequency (HF) |
| 300 KHz - 3 MHz | Medium Frequency |
| 30 KHz - 300 KHz | Low Frequency (LF) |
| 3 - 30 KHz | Very Low Frequency (VLF) |
| 300 Hz - 3 KHz | Voice Frequency |
| Below 300 Hz | Extremely Low Frequency |

Frequency modulation (FM) conveys information over a carrier wave by varying its frequency rather than amplitude.

FM Radio

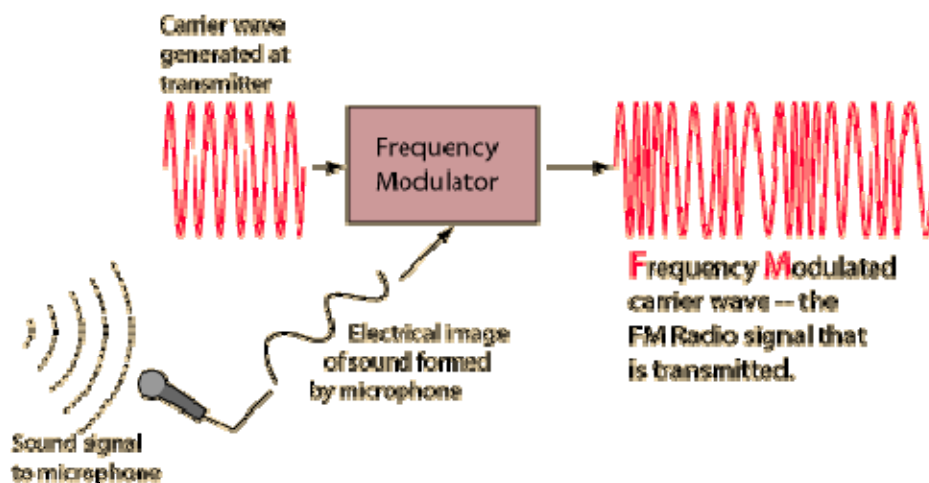

Hertz: Used to measure frequency. One hertz is equivalent to one cycle per second of electromagnetic energy. **Kilohertz:** refers to thousands of cycles per second of electromagnetic energy. **Megahertz:** refers to millions of cycles per second of electromagnetic energy. **Gigahertz:** refers to billions of cycles per second.

In-Band On-Channel (IBOC) or HD radio is a method of transmitting digital and analogue radio signals simultaneously on the same frequency. Digital information is ‘piggybacked’ on a normal AM or FM signal, avoiding the need for extra frequency use.

Integrated Services Digital Broadcasting–Terrestrial (ISDB–T): Terrestrial Integrated Services Digital Broadcasting (ISDB–T) is a wideband system similar to the DVB–T system employed in Australia for digital television. A key difference between the systems is that each ISDB–T service can be band segmented into 13 separately receivable sub-bands. One or three of these band segments can be used to provide sound broadcasting services and this is known as ISDB–TSB.

L band: a portion of the microwave band of the electromagnetic spectrum ranging roughly from 0.39 to 1.55GHz. It is used by some communications satellites and DAB in some countries.

Masking Pattern Adapted Universal Sub-Band Integrated Coding and Multiplexing (MUSICAM or MPEG layer 2 or MP 2): compresses digital information to be broadcast by discarding sounds that will not be perceived by listeners and packaging together information that remains for transmission.

Multiplex: DAB radio uses a multiplex to combine a number of programs into a single data stream for transmission. A DAB multiplex is made up of ‘bits’ which are used for carrying audio, data and an error protection system against transmission errors.

Narrowband: refers to a signal which occupies only a small amount of space on the radio spectrum.

Narrowcasting: Narrowcasting refers to services which cater to specialised interest groups or which are restricted to broadcasting in certain locations or at certain times.

Radio signals: Radio signals are comprised of radio frequency waves. These waves have three parts: wavelength, amplitude and frequency, each of which can be changed to carry information.

Radio wave: An electromagnetic wave propagated by an antenna. Radio waves have different frequencies and by tuning a radio receiver to a designated frequency a specific signal can be picked up.

Radio frequency spectrum: A radio wave is an electromagnetic wave propagated by an antenna. Radio waves have different frequencies. Tuning a radio receiver to a designated frequency can pick up a specific signal. Use of radio frequency bands of the electromagnetic spectrum is regulated by governments in a process known as frequency allocation or spectrum allocation.

In Australia, frequency allocation is undertaken by the Australian Communications and Media Authority See the [Australian radiofrequency allocation chart](#) for Australia in more detail at the Australian Communications and Media Authority website.

Single frequency network: A single frequency network is a network of several stations that broadcast the same signal simultaneously using multiple transmitters.

UHF: designates a range of electromagnetic waves whose frequency is between 300 MHz and 3 GHz. Waves whose frequency is above the UHF band fall into the microwave or higher bands, while lower frequency signals fall into the VHF or lower bands.

VHF: frequency range from 30 MHz to 300 MHz. Common uses for VHF are FM radio broadcast at 85–108 MHz, television, terrestrial navigation systems and marine and aircraft communications.

Wideband: Wideband refers to a transmission medium or channel that has a wider bandwidth than one voice channel (with a carrier wave of a certain modulated frequency). The wider the bandwidth, the greater the information carrying capacity—in radio a very narrowband signal can carry Morse code; a broader band can carry speech; a still broader band is required to carry music.

© Copyright Commonwealth of Australia

This work is copyright. Except to the extent of uses permitted by the *Copyright Act 1968*, no person may reproduce or transmit any part of this work by any process without the prior written consent of the Parliamentary Librarian. This requirement does not apply to members of the Parliament of Australia acting in the course of their official duties.

This work has been prepared to support the work of the Australian Parliament using information available at the time of production. The views expressed do not reflect an official position of the Parliamentary Library, nor do they constitute professional legal opinion.

Feedback is welcome and may be provided to: web.library@aph.gov.au. Any concerns or complaints should be directed to the Parliamentary Librarian. Parliamentary Library staff are available to discuss the contents of publications with Senators and Members and their staff. To access this service, clients may contact the author or the Library's Central Entry Point for referral.
